



SKILLS ONTARIO COMPETITION

Robotics (Teams of 4) Secondary

Video Contest Descriptions

Disaster Rescue Challenge Description:
<https://youtu.be/AoiCP531xAI>



Log Cabin Challenge Description:
<https://youtu.be/uqPHfZWwg00>



Last Updated: April 2021

LETTER FROM THE TECH CHAIRS

Dear Ontario Robotics Community,

For many of us, the Skills Ontario Robotics Competition at the Toronto Congress Center has been the highlight of our year. As rookie tech chairs, we were very excited to run the 2020 competition with Bob and learn as much as we could from him before he fully retired. It was very disappointing for all of us and especially for our students that the 2020 event had to be cancelled.

Despite the challenges we face, we would still like to provide a 2021 competition scope to schools and an opportunity for students to compete at the provincial level. Following in Bob's footsteps, we have produced two challenges for students in Ontario:

1. Log Cabin Construction - A tele-operated game, developed with the National Technical Committee, that will be used in the national contest.
2. Disaster Rescue – A purely autonomous challenge developed by Dan Kurz that will prepare Ontario teams for what they would face at the national contest.

We hope that teachers and community coaches will find creative ways to meet safely to design and build robots for these two challenges. In turn, we will work with Skills Ontario to find creative ways for teams to compete at the provincial level. We are confident that an event like ours that is built on innovation and problem solving will be able to find a way to be successful.

If you would like to be added to the Skills Ontario Robotics Email list, please send a message to dan.kurz@dsb1.ca and we will make sure you are kept up to date on any developments in our competition. You should also keep an eye on the Skills website for more information about the competition including the Q and A document and (new this year) video explanations of the challenges.

Thank you for all the work you put into your robotics team and for your flexibility as we work things out over the next few months. Feel free to reach out to either of us if you have questions or concerns about the event.

Sincerely,
Dan Kurz (dan.kurz@dsb1.ca)
Luca Comisso (gianluca.comisso@tcdsb.org)

TABLE OF CONTENTS

NOTES	4
COMPETITION INFORMATION GUIDE	4
SUBMISSION INSTRUCTIONS	5
CONTEST STATUS	7
PURPOSE OF THE CONTEST	7
SCORING	8
EQUIPMENT AND MATERIALS	8
SAFETY	8
1. TELE-OPERATED CONTEST: LOG CABIN CONSTRUCTION	9
1.1 DEFINITION OF TERMS REFERENCED IN THIS DOCUMENT	9
1.2 THE LOG-CABIN BUILDING TELEOPERATION GAME OVERVIEW	10
1.3 DETAILED COURT AREAS	10
1.4 DELIVERY OPTIONS	18
1.5 EACH TEAM'S EXCLUSIVE USE AREA IS APPROXIMATELY 8 ft. BY 16 ft	18
1.6 EACH TEAM'S AREA INCLUDES	19
1.7 LOG CABIN CONSTRUCTION GAME DESCRIPTION	23
1.8 SCORING SUMMARY	23
1.9 MARKING SHEET	25
1.10 PIT AREA AND COURT ACCESS	26
1.11 GAME PLAY	26
1.12 COURT LAYOUT	27
1.13 THE ROBOT(S) RESTRICTIONS	27
1.14 START OF THE GAME ROBOT STATUS	27
1.15 OVERALL TEAM ROBOT ENTRY SIZE	28
1.16 POWER SOURCES/MANAGEMENT	28
1.17 NON-ELECTRICAL (BATTERY) ENERGY SOURCES	29
1.18 RECOMMENDED ROBOT CONTROLLERS	29
1.19 PIT AREA	29
1.20 OVERALL COURT DESCRIPTION	30
1.21 PRE-INSPECTION FOR COMPLIANCE WITH SAFETY AND DESIGN RULES	31
2. AUTONOMOUS CONTEST: DISASTER RESCUE	32
2.1 CANISTER DELIVERY	34
2.2 DEBRIS	35
2.3 SERVER	36
2.4 THE LOBBY	37
2.5 GENERAL AUTONOMOUS RULES	38
2.6 TASK SPECIFIC RULES	38
2.7 COURT SET UP AND CONSTRUCTION	39
2.8 AUTONOMOUS SCORE CHART	40
APPENDIX A - AUTONOMOUS ROBOT INSPECTION CHECKLIST	41
APPENDIX B - PHOTOS OF THE COURT	42
APPENDIX C – DRAWINGS OF THE COURT	44

NOTES

To ensure that competitors have a positive experience at the Skills Ontario Competition, a competitor and their educator should review the scope document well in advance, as well as check back to the website for updated versions of the scope up until the event.

For technical questions that are contest specific, please contact Dan Kurz at dan.kurz@dsb1.ca or the Skills Ontario competition department at competitions@skillsontario.com.

TECHNICAL CO-CHAIRS:

Dan Kurz, District School Board Ontario North East, dan.kurz@dsb1.ca

Luca Comisso, Toronto Catholic District School Board, gianluca.comisso@tcdsb.org

SKILLS ONTARIO COMPETITIONS DEPARTMENT

competitions@skillsontario.com

COMPETITION INFORMATION GUIDE

Both the **Competition Information Guide** and contest **Scope MUST** be reviewed in full for all pertinent and vital information in regards to the competition.

The Competition Information Guide can be found at <http://www.skillsontario.com/competitions/secondary>

Examples of required information from the Competitions Information Guide to accompany the Contest Scope:

- **Competitor Eligibility**
- **Competitor Rules & Regulations**
- **Conflict Resolution Procedure**
- **Skills Canada National Competition/ WorldSkills**
- **Team Ontario**
- **Space Reservation/ Registration/ Wait List Policy**
- **Closing Ceremony/ Ticket Purchases**
- **Spectators**

SUBMISSION INSTRUCTIONS

To simplify the logistics of participating in this competition safely we have decided to change the format from “remote virtual” to video submissions. Teams will be required to submit specific videos that demonstrate their robots by **April 27th at 4:00pm**. The videos can be submitted any time before that date.

Please take careful note of the video requirements and submission instructions below.

General Video Instructions

- All videos must use the .mp4 format.
- Each video must start by identifying your team and the title of the video. This can be with a sign, spoken or both.
- The video descriptions below each have a video code that must be included in the file name along with your school board initials. Each video file should start with your school board initials then a space, followed by the video code.

For example, if your school board was District School Board of Niagara the file name of your Tele-Op Robot and Court Inspection Video should be:

DSBN TRIV.mp4

Note: If your school board has more than 1 team, add your school initials to the file name as well.

- It is each team’s responsibility to ensure that their courts are built according to the scope. If a judge notices something that is not in compliance with the scope your team may be disqualified. Feel free to send photos of your courts to the Tech Chairs ahead of time for verification.
- Coaches or non-team members are permitted to help with recording or time keeping.
- Everyone shown in the video must be practicing all school based COVID-19 safety protocols required by your local public health unit at the time of the recording.
- Inspection videos can be shot in multiple parts and edited.
- Demonstration videos may **not be edited in anyway**, including titles or score tallying at the end.

Submission Link: <http://www.skillsontario.com/virtual-competition-submissions>

- Up to 25 files can be uploaded at once, with each file being a maximum of 1 Gb.
- Any files larger than 1 Gb will need to be uploaded to Dropbox. A link to the Dropbox folder will be provided on the submissions page.

Required Videos: (7 in total)

Tele-Op Robot Inspection Video (Video Code: TRIV)

Time Maximum: 8 Minutes

Outline:

- i. Identify your School Board, School and introduce the team members that worked on this part of the competition.
- ii. Do a “walk around” of your robot(s) and explain the key features and the innovations you are most proud of.
- iii. Show the fuse protection on your robots.
- iv. Show that the robot can be turned off with a single motion
- v. Use tape measure to clearly show the length, width and height of the starting configuration of your robots. Demonstrate that it is less than 4 cubic feet.

- vi. Show that your entire entry (all of your tele-op robots) fits on the starting platform without hanging over.

Autonomous Robot Inspection Video: (Video Code: ARIV)

Time Maximum: 8 Minutes

- i. Identify your School Board, School and introduce the team members that worked on this part of the competition.
- ii. Do a “walk around” of your robot(s) and explain the key features and the innovations you are most proud of.
- iii. Show the fuse protection on your robots.
- iv. Show that the robot can be turned off with a single motion
- v. Show that your bot fits within a 16”x16”x16” cube. (Demonstrate that the maximum length, width and height are all less than 16”)
- vi. Show the fuse protection on your robot.

3 Tele-Op Demonstration Videos (Video Code: TDVx, where x is the demonstration number 1, 2 or 3)

- i. Identify your school board and School
- ii. Position the camera at the midpoint of one of the long sides of the court so that the whole court is visible in the frame.
- iii. Place a 4-minute countdown timer opposite the camera, outside of the court and at a height that is easily visible.
- iv. Someone should say “ready, set, go” and the timer should start.
- v. Once the timer hits 0 all robots must stop.
- vi. Complete the score chart found in the scope and clearly show it to the camera.*

*Note: A judge will also tally your score and if there is any discrepancy you will be contacted and given a chance to explain the difference.

2 Autonomous Demonstration Videos (Video Code: ADVx, where x is demonstration 1 or 2)

- i. Identify your school board and school.
- ii. Position your camera looking down on the court behind the lobby such that the whole court is visible.
- iii. Place an 8 minute countdown timer across from the camera outside of the back wall.
- iv. Once the robot is placed in the lobby, roll a dice to determine the server location (See Below*). Make sure the dice roll is clearly visible in the camera.
- v. Someone should say ready, set, go at which point the timer should start and the robot may start.
- vi. Once the timer hits 0 or the demonstration is over, complete the score chart found in the scope and show it to the camera. *

*Note: A judge will also tally your score and if there is any discrepancy you will be contacted and given a chance to explain.

Server Location*

The location of the server will be determined at the start of each demonstration by the roll of a 6 sided dice and this diagram:

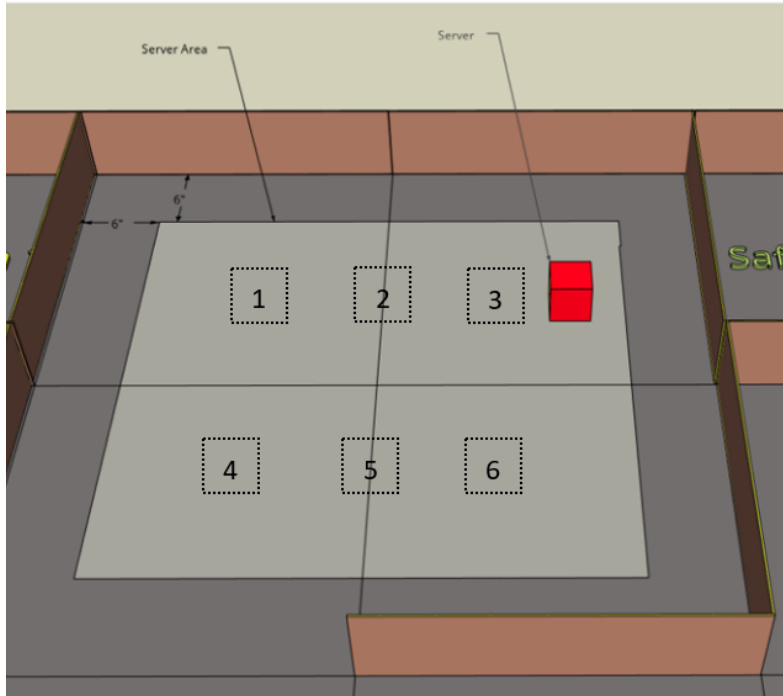

Note: The positions are centered within the squares that make up the server area not the tiles themselves.

CONTEST STATUS

- This contest is offered as an official contest
- This contest is offered at the Skills Canada National Competition (SCNC), team of 2

PURPOSE OF THE CONTEST

The purpose of the Skills Robotics Competition is for students to develop design, engineering and building skills as they collaborate to solve authentic problems.

SCORING

- Tele-Op Robot (Log Cabin) = 60%
- Autonomous Robot (Disaster Rescue) = 40%
- Scoring: Total 100 Marks
- **Tele-Op (Log Cabin) Marks (60)**
 - A team's total score is the sum of their Tele-Op demonstrations.
 - The highest scoring Tele-Op team receives 60 Marks
 - All Other Teams are awarded marks based on the following formula:
 - $(60) \text{ (Individual Tele-Op Score / Highest Tele-Op Score)}$
- **Autonomous (Disaster Rescue) Marks (40)**
 - A team's total score is the sum of their 2 autonomous demonstrations.
 - The highest scoring autonomous team receives 40 Marks
 - All other teams are awarded marks based on the following formula:
 - $(40) \text{ (Individual Autonomous Score / Highest Autonomous Score)}$
- A teams total score is the sum of their Tele-Op marks and their Autonomous marks.

EQUIPMENT AND MATERIALS

TELE-OPERATED CONTEST: LOG CABIN CONSTRUCTION

See Appendix C for the complete list of materials to build the court.

AUTONOMOUS CONTEST: DISASTER RESCUE

The court and parts will be constructed out of the components found in the Tetrix - "Competition in a Box" set available from Studica.

<https://www.studica.com/ca/fr/SkillsCanada/skills-canada-tetrix-max-competition-in-a-box.html>

SAFETY

Safety is a priority at the Skills Ontario Competition. At the discretion of the judges and technical chairs, any competitor can be removed from the competition for not having the proper safety equipment and/or not acting in a safe manner.

*Competitors will not be permitted to compete until they have the needed safety equipment. Competition judges will have final authority on matters of safety

Competitors must show competence in the use of tools and/or equipment outlined in this scope and can be removed at the discretion of the judges and technical chairs if he/she does not display tool and/or equipment competency.

1. TELE-OPERATED CONTEST: LOG CABIN CONSTRUCTION

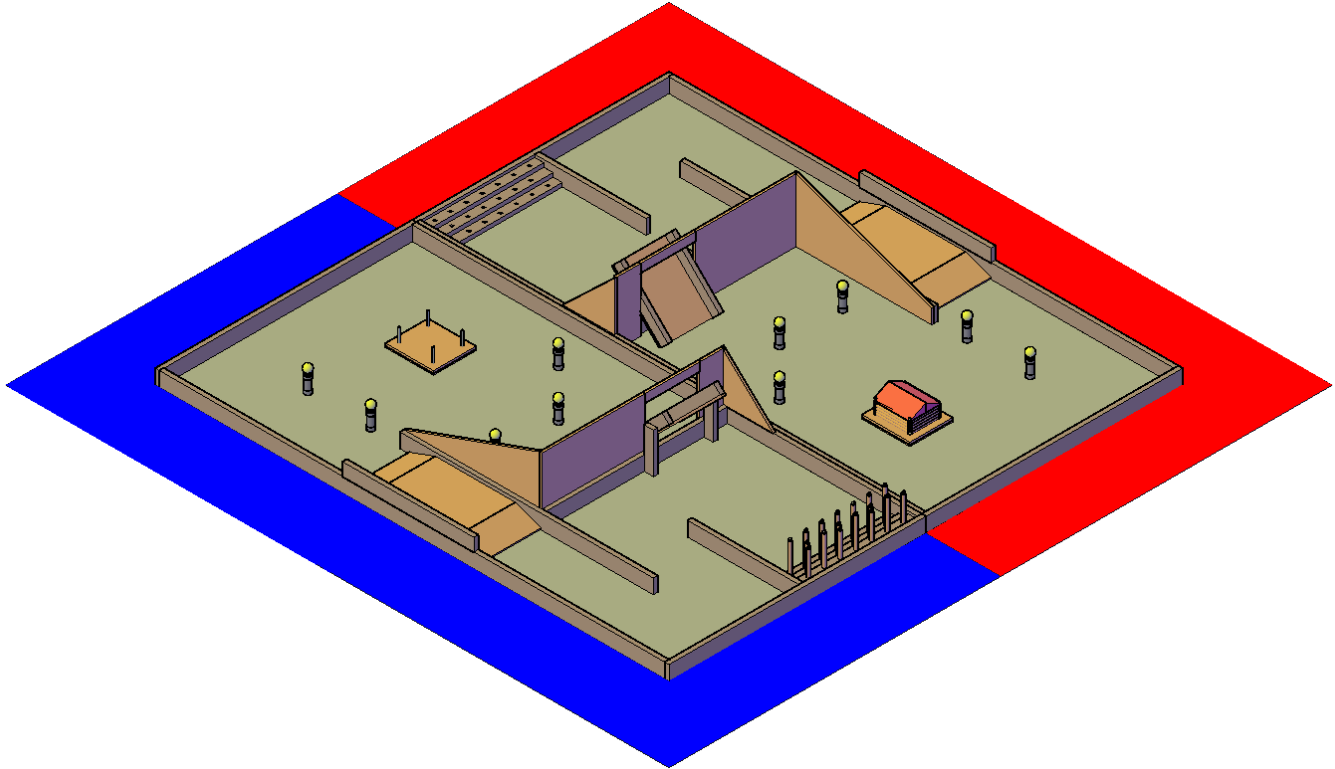

1.1 DEFINITION OF TERMS REFERENCED IN THIS DOCUMENT

- a. Tele-Operated Robot Elements are elements under the direct/active control of competitors during game play using one or two radios/game controllers held by the courtside competitors.
- b. Mobile Independent Autonomous Mobile Robot Elements are elements that at the start of a game have a competitor pressing their start button or enter on a computer keyboard as the only competitor to Independent Autonomous Mobile Robot Element communication during the entire game.
- c. Stationary Independent Autonomous Elements are elements that have their power on at the start of games but have no direct contact with a competitor during game play. These units may interact with the team's tele-operated mobile robot with the actions of the tele-operated mobile robot triggering an active response by the Independent Autonomous Element which may be managed either by a mechanical based system (eg. A series of limit switches / no programmed elements) or a pre-programmed system (eg. Managed by an Arduino or other microprocessor) internal to the Independent Autonomous Element.

1.2 THE LOG-CABIN BUILDING TELEOPERATION GAME OVERVIEW

- a. The core game situation requires a Robot or Robots to use the components provided in their Exclusive Use Court Space to (a) Harvest the trees and deliver the logs to the build site and (b) to Build the Log Cabin ON the Designated Foundation in the Assigned Robot Assembly Area.

1.3 DETAILED COURT AREAS

1.3.1 The Trees

Teams have use of 20 trees/logs:

- a. Each tree/log will be constructed out of a 1 inch diameter wooden dowel. 10 trees/logs will measure 10 inches long. 10 trees/logs will measure 12 inches long.
- b. On each end of each tree/log there will be an eye hook. These eye hooks will be oriented in the same plane, as shown in Figure 1.
- c. At the start of the game, the trees will be located in the designated forest area, standing upright.
- d. At no point are the trees allowed to be thrown by robots or people. This includes during competition matches and during non-competition match times.
- e. Trees will be marked for use on each side of the court using colored stripes applied by marker. This will ensure the trees/logs used on each side are the ones originating on that side. Teams are not allowed to use trees/logs from the other team.

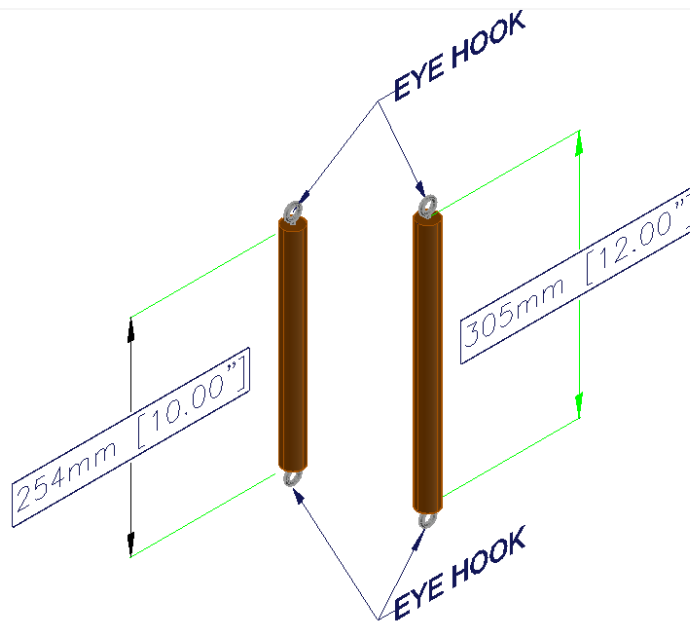

1.3.2 Forest

Each team will have a designated forest area where the trees will initially be located:

- a. Each team's forest will be made of 3 rows of trees, each at a different base level:
 - i. First row of trees will be at a base level of 1.5 inches.
 - ii. Second row of trees will be at a base level of 3 inches.
 - iii. Third row of trees will be at a base level of 4.5 inches.
- b. The rows will contain a set arrangement of trees:
 - i. First row will contain 7 trees, all of the longer variety (12 inch dowel)
 - ii. Second row will contain 6 trees, all of the shorter variety (10 inch dowel)
 - iii. Third row will contain 7 trees, alternating in height in the pattern: Short-Long-Short-Long-Short-Long-Short
- c. Trees in the same level will be located at 6 inch increments (measured center to center).
- d. The first and third levels will align, while the second level will be offset by 3 inches.
- e. The trees will be standing upright, in holes drilled 1 inch diameter by 1.5 inch depth (the tree should be able to slide in and out of the hole easily).
- f. The forest base will be secured to the court.

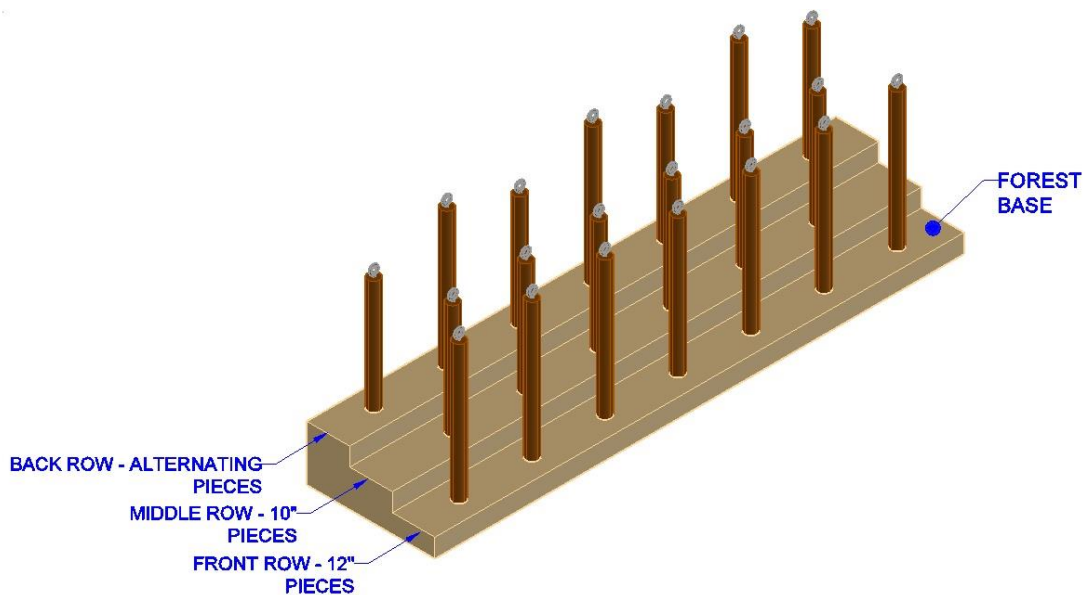

1.3.3 Cabin Foundation

Each team will have a designated cabin foundation and building area:

- The cabin foundation will be constructed of 2 pieces of $\frac{3}{4}$ inch plywood stacked on top of each other. The plywood pieces will measure 16 inches by 18 inches.
- The foundation will have 4 bolts (5/16 inch diameter, 6 inch long) standing vertically to hold the logs. (2.5 inches from each side forming a 13x11 inch rectangle). These bolts will stand 5.25 inches above the foundation surface.
- The cabin foundation will be secured to the court surface.

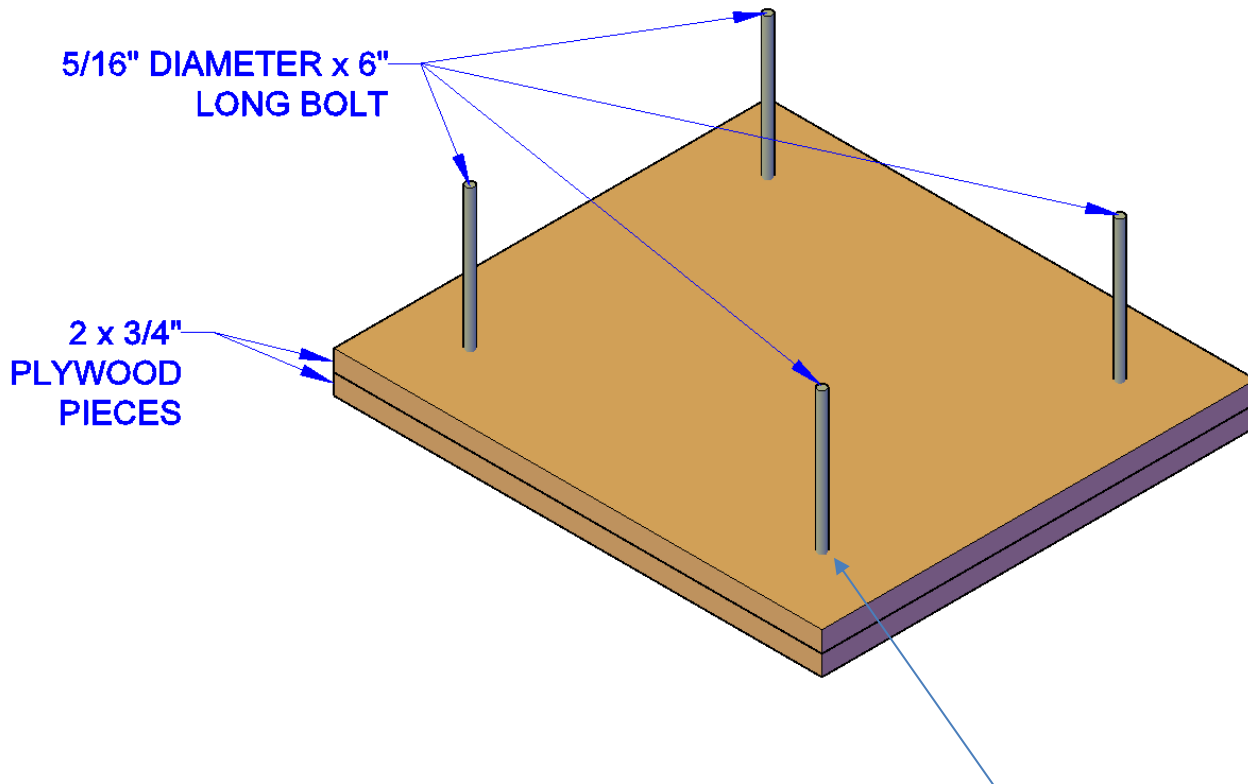

Figure 3: Cabin Foundation

- Secure bolts with a nut and washer to the top board. Drill a 1" hole in the bottom board to accommodate the heads of the bolts*

**This modification is not in the national scope*

1.3.4 Starting Platform

The Robots will start in a designated starting area. This starting area is on top of a platform in the pathway:

- a. The starting platform measures 24 inches by 30 inches, 4.25 inches above the court floor level.
- b. The platform will have ramps on each side along the pathway. These ramps are 10.25 inches in length.
- c. A team's entire entry must start on top of the starting platform and must not break the vertical plane formed by the edges of the top of the platform. They must fit within the 24 inch by 30 inch starting platform (and must conform to the overall volume restrictions).

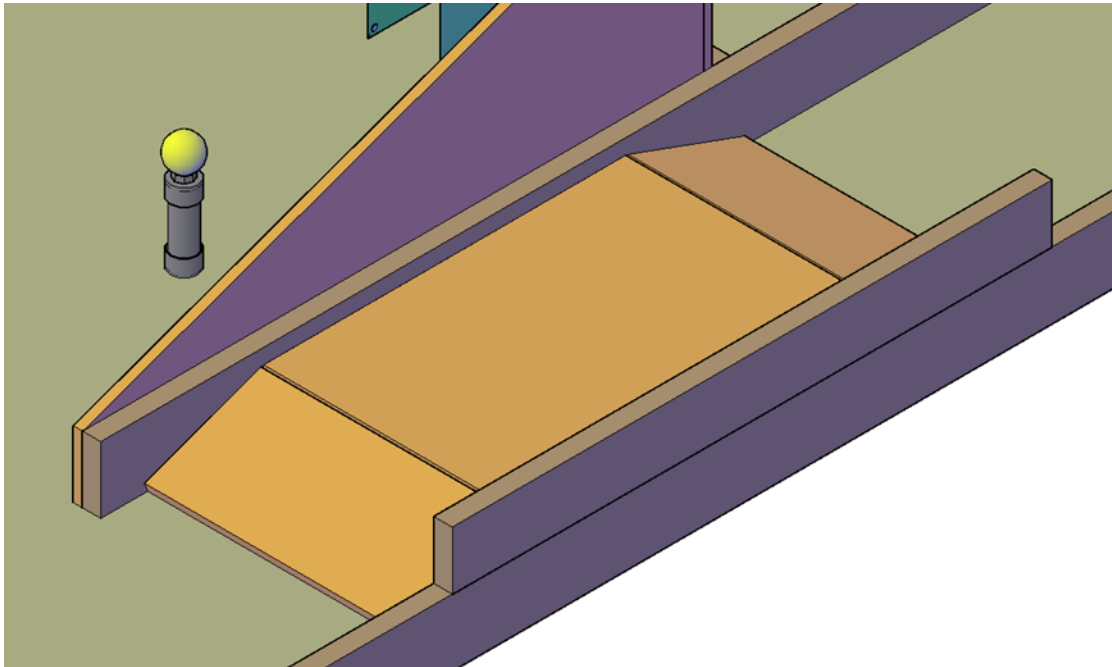

1.3.5 River and Pathway

To deliver the logs from one side to the other, competitors must either use the pathway or send the logs down the “river”.

- a. The forest side and the construction side of the challenge are separated by a 24 inch high barrier. Logs are not allowed to be passed over this barrier.
- b. The pathway is the 24 inch wide section going from one side to the other.
 - i. Walls of this pathway are constructed using 2x6s.
 - ii. The Starting Platform is located along this pathway.
 - iii. Teams are not allowed to reach over the walls of the pathway.

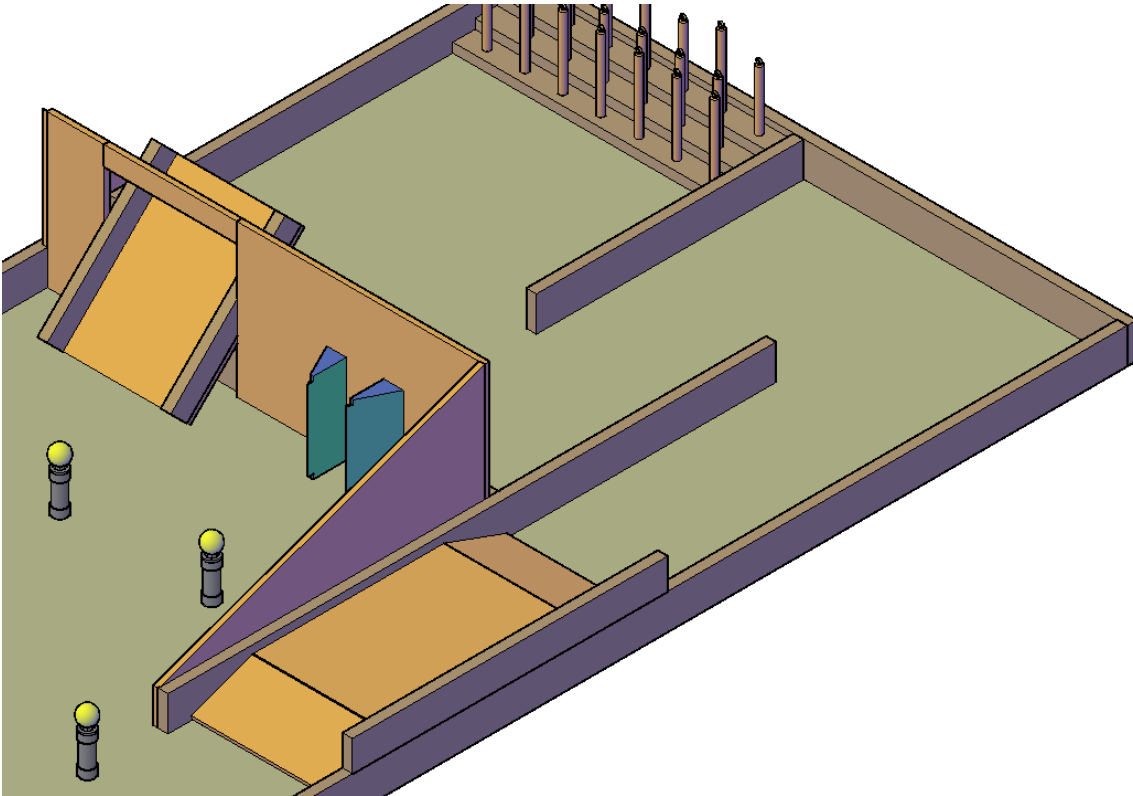

- c. The River is a chute designed to send the logs from the forest side to the building side.
- i. The river is a ramp for logs only. Robots are not to travel along the river.
 - ii. The river is a 45 degree angled ramp, 18 inches in height on the forest side, and runs directly to the floor level on the building side. The middle of the river is straddling the middle wall.
 - iii. There is a hole in the middle barrier directly above the river to allow logs to pass through to the other side.
 - iv. The river is 18 inches wide.
 - v. The river has a 2x4 lip on the edges.

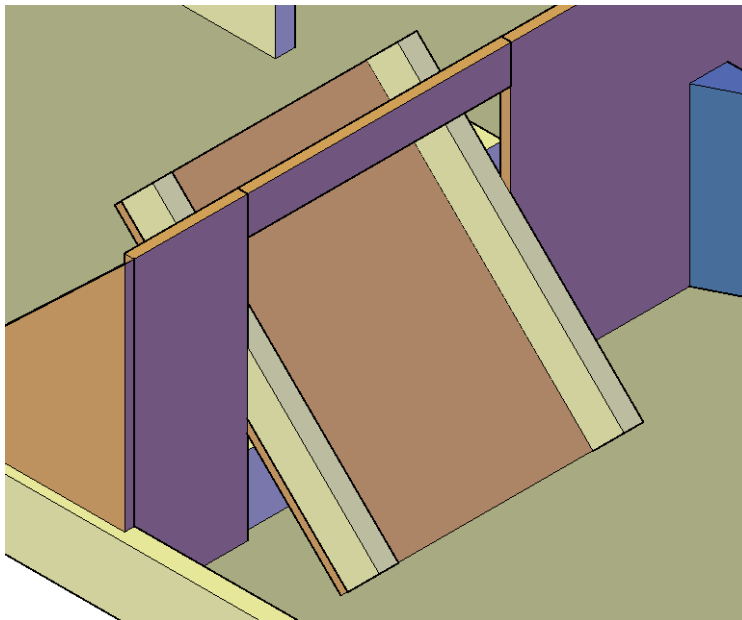

1.3.6 Power Poles

Located in the Cabin Building Zone, there are 5 Power Pole obstacles.

- a. Each power pole consists of a 6 inch long 1.5 inch diameter ABS pipe, capped on both ends. The caps used are identified in the parts list at the end of this document (with the court dimensions and parts).
- b. The secured test caps will be cut to 3/8" long and fastened to the floor with double sided tape*.
- c. On the top of the ABS pipe, on top of the cap, there will be a 1 inch hex nut secured to the top. On top of the hex nut is where a standard tennis ball will sit.
- d. The cap on the bottom of the ABS pipe will be secured to the court surface. The ABS pipe will be fitted into this cap, but will be able to be knocked loose from the base cap.
 - i. Knocking the ABS pipe from the cap onto the court surface will not be considered damage to the court.
 - ii. Any action by the robots which cause the secured cap to break away from the court surface may be considered damaging the court, and would be treated as such.
- e. For each power pole standing at the end of the match, 1 point will be awarded. For each tennis ball remaining on top of the power pole at the end of the match, 1 point will be awarded.

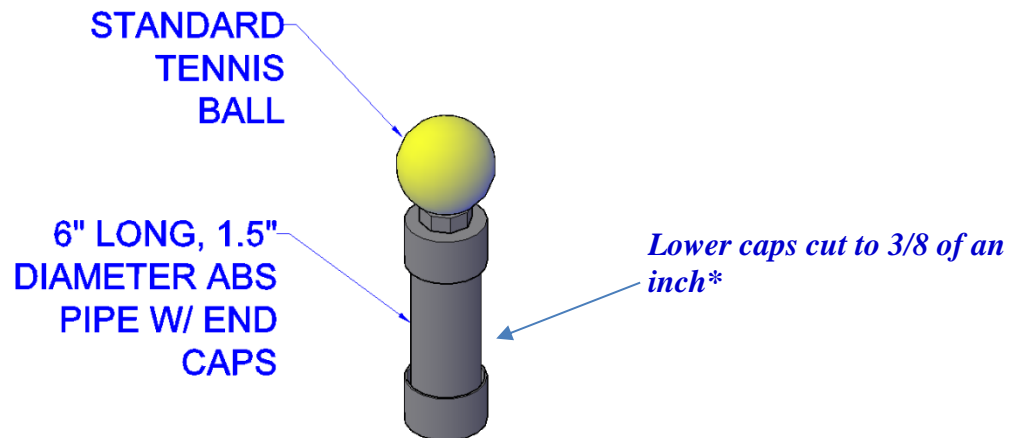

** Not included in national scope*

1.3.7 Log Cabin Construction

Building the Log Cabin involves:

- a. Delivering the logs to the cabin foundation
- b. Placing the logs onto the corner bolts of the foundation:
 - i. Each log must be placed with its eye hooks on 2 corner bolts to be considered as part of the cabin.
 - ii. Each wall will consist of 5 logs.
 - iii. 2 walls will use the 12 inch dowels. 2 walls will use the 10 inch dowels.
- c. Two roof pieces are to be placed on top of the walls.
 - i. Roof pieces are right triangular prisms constructed out of foam blocks.
 - ii. The roof pieces are right triangular prisms measuring 6 inches x 3 inches x 14 inches.
 - iii. The roof pieces will start on the cabin construction side of the playing field, along the middle wall, touching the middle wall, 12 inches from the starting platform wall, and 6 inches between each piece.
 - iv. Roof pieces are the top of the cabin.
 - v. Roof pieces will be scored based on being placed on top of the last fully complete level of logs.
- d. A completed Log Cabin will consist of 20 logs and 2 roof pieces.
 - i. The complete cabin will consist of 6 levels.
 - ii. 5 levels containing 4 logs each, and one level containing 2 roof pieces.
- e. The first team to complete a full cabin and return all their robots to the starting platform will receive one point.
 - i. Robots returning onto the starting platform will be considered on the starting platform if the robot is free standing on the starting platform without touching the any surface other than the starting platform.

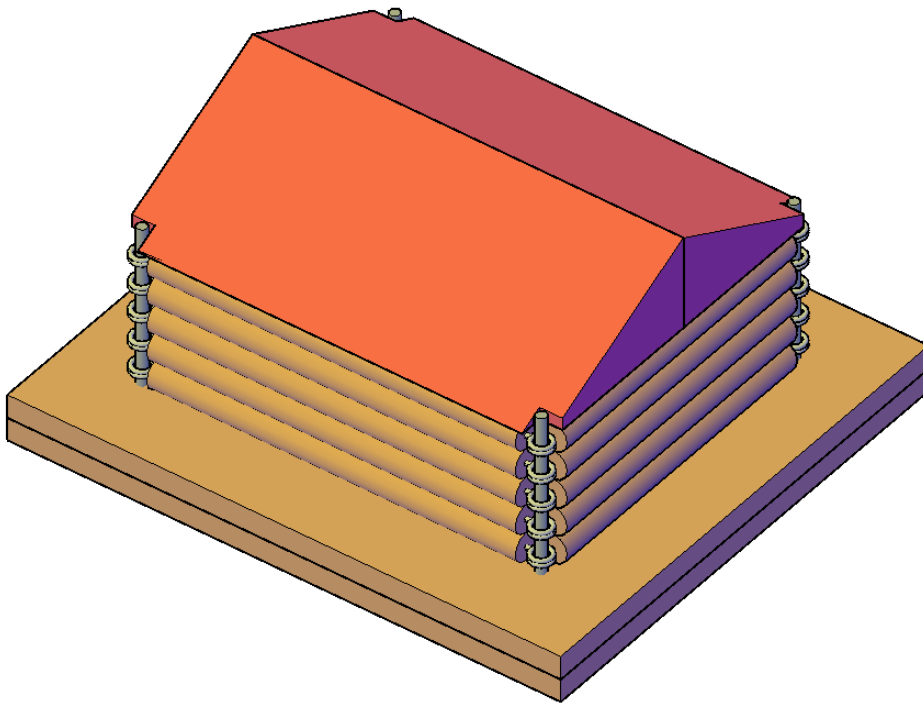

Figure 8: Fully Constructed Cabin

1.3.8 Additional Notes

- a. Robots cannot reach over or through any wall to deliver a log.
- b. Robots cannot reach over the middle barrier wall to deliver a log to the cabin assembly area.
- c. Robots cannot transfer the log over the middle barrier wall.
- d. Should any piece fall outside of the competitors playing area, the piece will be considered out of play for the remainder of the match. The pieces will be marked with a colored marker to keep track of these.

1.4 DELIVERY OPTIONS

- a. Teams have One Travel Option for moving between the Forest area and the cabin building area (the pathway).
- b. Teams have 2 options for delivering the logs from the forest area to the cabin building area.
 - i. **Option One:** Carry the logs from one side to the other through the pathway, which contains a raised platform and ramps, OR
 - ii. **Option Two:** Send the logs down the river from the forest area to the cabin building area.

1.5 EACH TEAM'S EXCLUSIVE USE AREA IS APPROXIMATELY 8 ft. BY 16 ft.

- a. Teams have Exclusive Use of a 30 in. wide passageway along three sides of their assigned court area.
- b. Both Team Members can be active in and move throughout this entire team passageway space during game play.
- c. It is a Team Responsibility to define the tasks assigned to each competitor.
- d. If a Team has a Two Robot Entry, then:
 - i. Both competitors can be Robot Drivers
 - ii. Both competitors can also be Spotters for their partner driver
- e. If a Team has a One Robot Entry, then:
 - i. One competitor can be the Robot Driver and One competitor can be a Spotter for their partner driver

1.6 EACH TEAM'S AREA INCLUDES:

1.6.1 Starting Platform

- a. Each team area will have one starting platform.
- b. The starting platform measures 24 inches by 30 inches. Teams robots must start on top of the starting platform, and must not break the vertical plane created by the edges of the top of the platform.
- c. The platform is 4.25 inches above the court surface, and has a ramp on each side.
- d. The outside wall along the starting platform will have a raised section constructed by an additional 2x6 on top of the 2x6 exterior wall.
- e. The starting platform is located along the pathway which connects the 2 sides of the court.

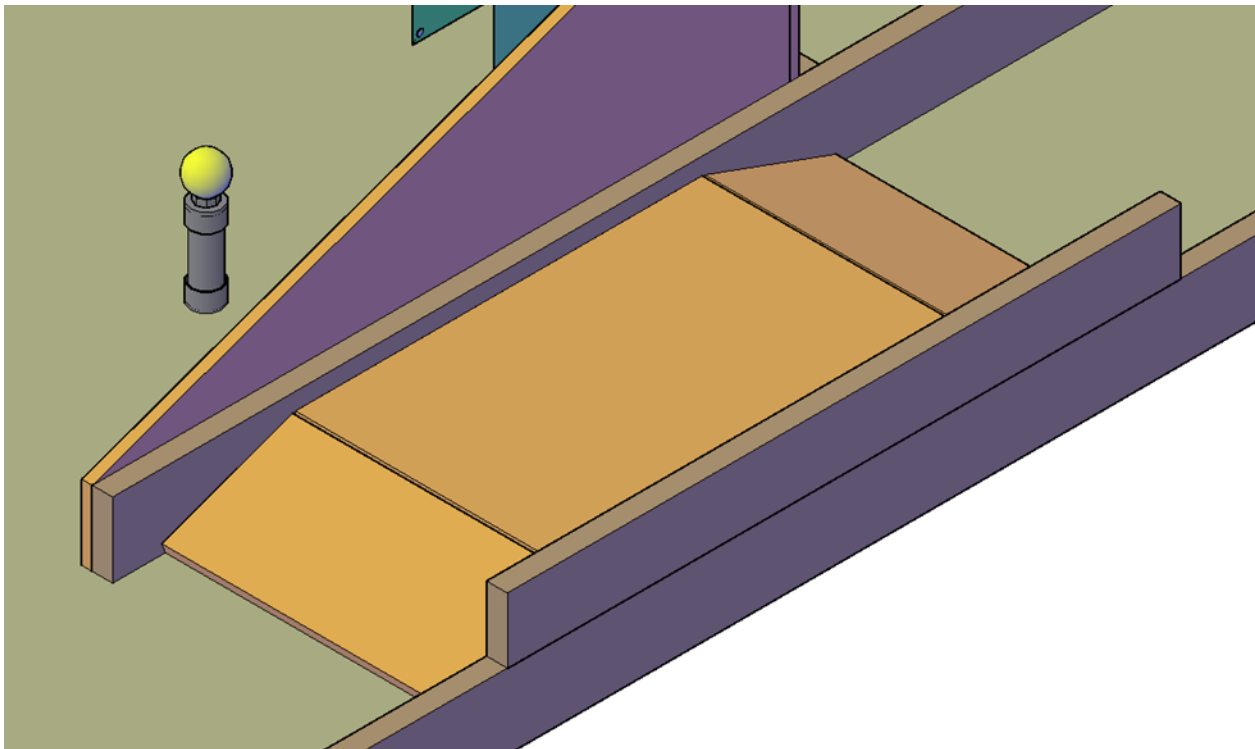

1.6.2 Forest Area

- a. Each team will have access to one forest area, separated by a 24 inch high wall from the cabin building area.
- b. At the beginning of the match, the forest will contain 20 trees, standing upright in 3 rows.
 - i. Front row will contain 7 trees of 12 inches in length with an eye hook on each end (total measurement being approximately 14 inches)
 - ii. Second row will contain 6 trees of 10 inches in length with an eye hook on each end (total measurement being approximately 12 inches)
 - iii. Back row will contain 7 trees, alternating in height. The trees will appear in the order: 10 inch, 12 inch, 10 inch, 12 inch, 10 inch, 12 inch, 10 inch
- c. Teams must harvest the trees from their own forest to construct their cabins. Teams are not allowed to use the trees from the competing team in construction of their cabin.

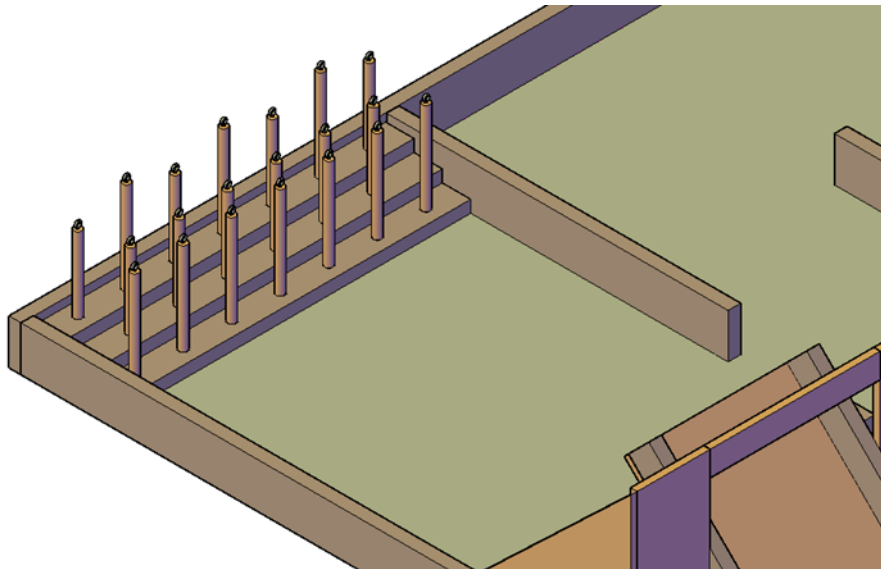

1.6.3 Cabin Building Area

- a. Each team will have access to one Cabin building area, separated by a 24 inch high wall from the forest area.
- b. The cabin building area includes 5 power pole obstacles, and one cabin foundation. See details above for these items.
- c. Teams will construct their cabins on the provided foundation.

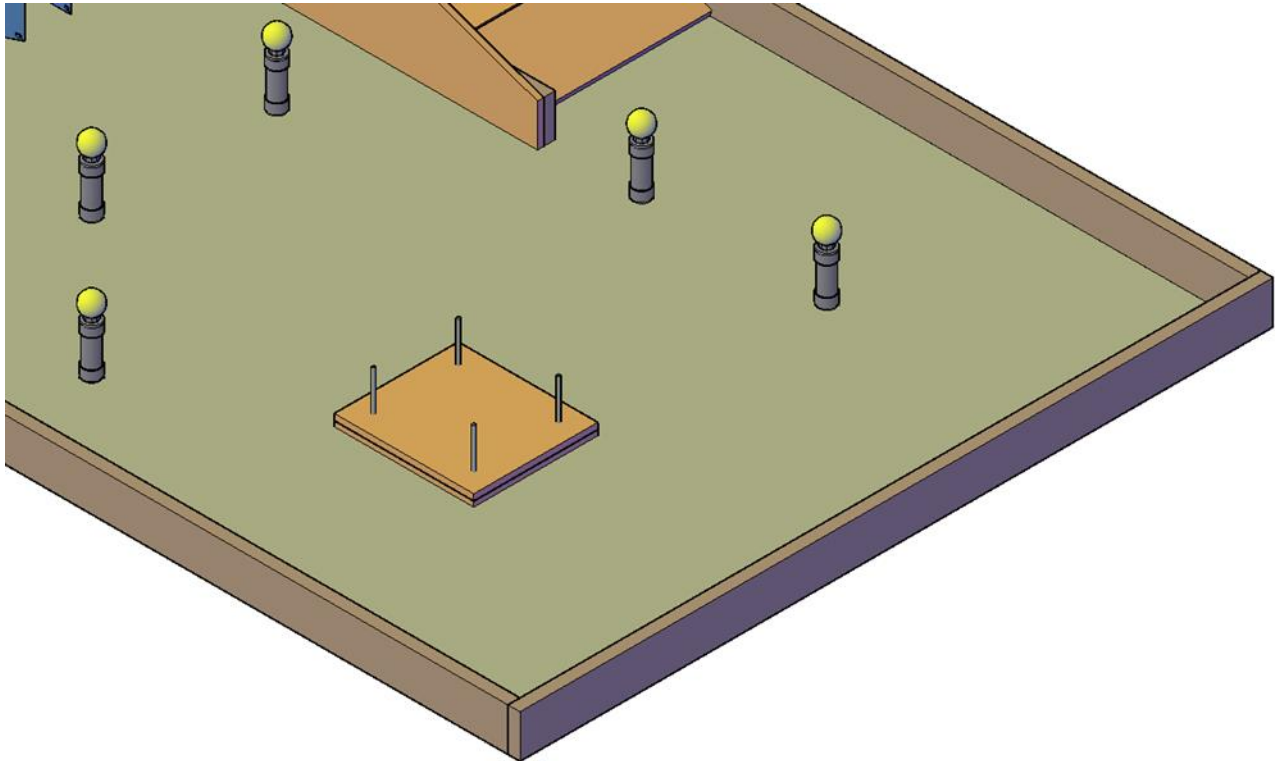

1.6.4 River and Middle Wall

- a. Separating the forest area and the cabin building area is a wall standing 24 inches in height.
 - i. Robots are not allowed to reach over the wall.
 - ii. Trees are not allowed to be transferred over the wall.
- b. Located in the wall is the River, which provides a chute to send the trees from one side to the other.
 - i. The river is 18 inches wide.
 - ii. The river is at a 45 degree angle.
- c. The river is meant only for transportation of trees/logs from one side to the other.
 - i. Robots are not allowed to travel across the river to go from one area to the other.

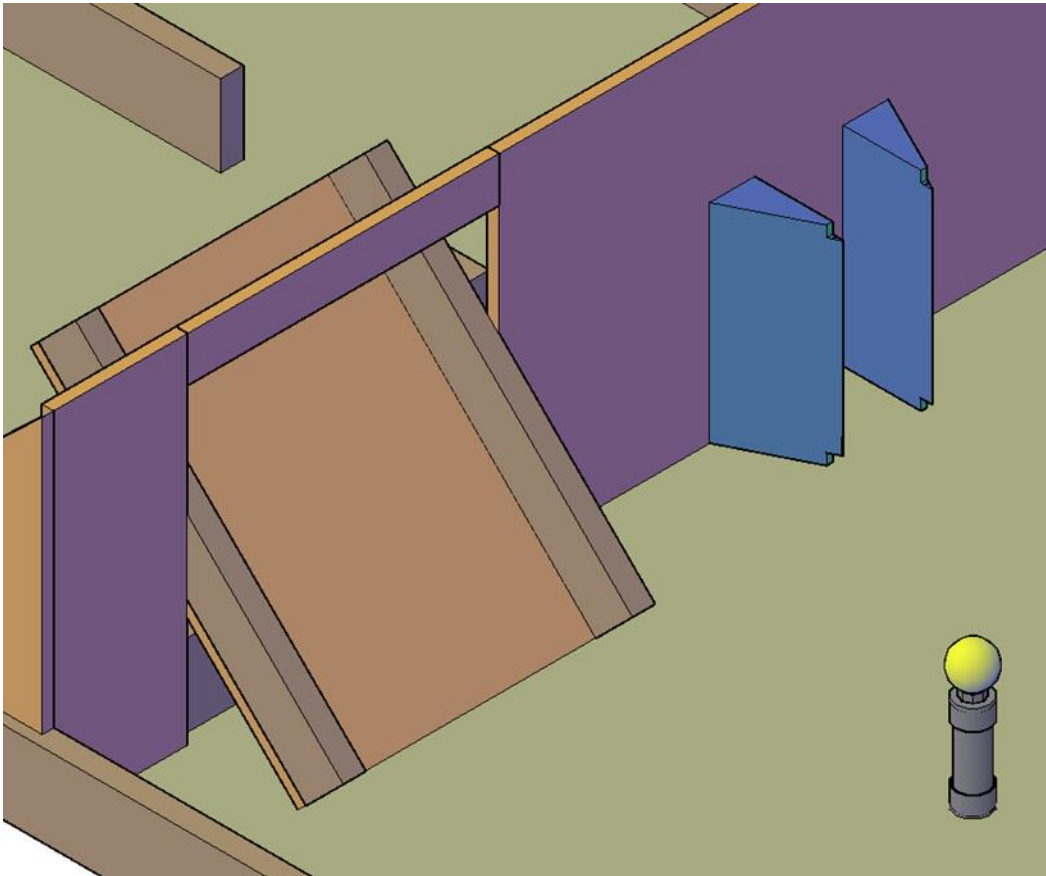

1.7 LOG CABIN CONSTRUCTION GAME DESCRIPTION

- a. Games will involve Two Teams at a time.
- b. Both Competitors are allowed unrestricted movement around the perimeter of their Team's Assigned Court Area.
- c. Each robot may possess a **Maximum of ONE Piece** at a time.
- d. Teams can utilize a Maximum of TWO Tele-operated Robots.
- e. Teams may also use Independent Autonomous Element(s) as part of their entry (which must fit into the overall size limitation at the beginning of the game).
- f. Teleoperated Robots may NOT be in possession of any trees or components at the Start of a game.

1.8 SCORING SUMMARY

Scoring will be done at the end of each 4 min. match:

1.8.1 Delivery Points

- a. One point will be awarded for each log successfully delivered onto the cabin building foundation.
- b. The log must be supported fully on the foundation for points to be awarded (it cannot be touching the court floor).
- c. Two points will be awarded for each Roof piece successfully delivered onto the cabin building foundation.

1.8.2 Log Cabin Building Points

- a. A complete Log Cabin has a Maximum of 6 Levels and the point value awarded increases as you move up through the layers.
 - i. Pieces on level one must be Logs (the roof pieces must be on top of at least one completed wall level to count for construction points).
 - ii. Pieces on level 2-5 can be either Logs or Roof pieces.
 - iii. Pieces on level 6 can only be the Roof pieces.
- b. Pieces on the first level of a wall are worth 1 point.
- c. Pieces on the second level of a wall are worth 2 points.
- d. Pieces on the third level of a wall are worth 3 points.
- e. Pieces on the fourth level of a wall are worth 4 points.
- f. Pieces on the fifth level of a wall are worth 5 points.
- g. Pieces on the sixth level of a wall are worth 6 points.
- h. The roof pieces will score as being on the level directly above the last fully completed wall level. For example, if you have 3 fully built wall levels and place the roof pieces on top, the roof pieces will count as they are on the fourth level.

1.8.3 Power Pole Points

- a. Competitors will be awarded points for Power Pole(s) which remain intact.
- b. 1 point will be awarded for each pole still standing.
 - i. A pole is considered standing if the ABS pipe is still standing within the secured cap.
 - ii. The pole does not need to be standing fully upright, as long as it is still in the secured cap and being supported by the secured cap.
 - iii. If the pole is touching the court surface, it will not be considered standing.
- c. 1 point will be awarded for each tennis ball which remains on top of the power pole.
 - i. The tennis ball is considered on top of the power pole if it is fully supported by the power pole.
 - ii. If the tennis ball is touching anything else, it will not be considered supported by the power pole.
- d. The Power Pole Points will be awarded at the end of each match.
- e. If a Power Pole or Tennis ball becomes knocked over during a match, it is considered knocked over.
 - i. Competitors will not be allowed to rebuild these Power Poles. Once they are knocked over, they are no longer eligible for points.

1.8.4 Scoring Notes:

- a. The log cabin levels for each side are counted from the bottom most log placed on each side. For example, if three levels of logs are constructed on one side, and then a log is placed on an adjoining wall, the log on the adjoining wall would be counted as being on the first level.
- b. The points awarded based on the level a piece is placed in the Cabin are displayed in the Robot Marking Sheet. Marks assigned increase by **ONE point per layer** as you move up the Cabin structure.
- c. The first team to complete a full cabin and return all their robots to the starting platform will receive one point (timing information may be used when considering a tie-breaker).
 - a. Robots returning onto the starting platform will be considered on the starting platform if the robot is free standing on the starting platform without touching the any surface other than the starting platform.
 - b. Autonomous elements do not need to return to the starting platform to receive the bonus point*.

** This rule is not included in the national scope.*

1.9 MARKING SHEET

2021 Skills Canada Quebec City Robotics			
Log Cabin Construction Scoring Sheet			
Delivery	Number of Pieces	Points per piece	Delivery Score
Logs		x 1pt	
Roof		x 2pt	
Total Delivery Score:			
Power Poles	Number intact	Points per standing	Power Pole Points
Balls on top		x 1pt	
Poles standing		x 1pt	
Total Power Pole Score:			
Cabin	Number of Pieces	Points per piece	Score per level
Level 1 Logs		x 1pt	
Level 2 Pieces		x 2pt	
Level 3 Pieces		x 3pt	
Level 4 Pieces		x 4pt	
Level 5 Pieces		x 5pt	
Level 6 Pieces Completed		x 6pt	
Game First?		+ 1pt	
Total Cabin Score:			

Team Name:	Competitor Signature:
	Total Score:

1.10 PIT AREA AND COURT ACCESS

- a. A pit area is provided so that students may make repairs and improvements to their robots between games. (Note: Teachers are not permitted in the pit area once the competition has started).
- b. Teams **MUST** bring their Robots into the skill area at Orientation. Teams are **NOT** allowed to remove their robots from the skill area during the over-night periods between Orientation Day, Competition Day 1, and Competition Day 2 of the contest.
- c. Laptops may be removed overnight by competitors.
- d. The pit area and contest court may be available to teams to work or practice during lunch breaks if an NTC committee member is present.

1.11 GAME PLAY

- a. Teams may participate in a 'Round Robin Tournament' leading to a 'Seeded Double Elimination Playoff Tournament'.
- b. Log Cabin Construction Tournament Standing will be based on the total number of points scored in all games played by each team.
- c. Teams will play a balanced number of Tournament Games.
- d. Teams will participate in an equal number of Games in the Round Robin Tournament.
- e. There may be Log Cabin Construction Playoff Games.
- f. Tournament games will last 4 minutes.
- g. The amount of time between games will be determined by the number of participants. This information will be provided to teams at the start of the tournament.
- h. Between tournament games, battery changes and repairs to robots may be completed at the team's assigned Pit Area Worktable.
- i. During the competition, protective safety glasses are expected to be worn while performing material removal tasks (cutting, drilling, etc.).
- j. During game play, referees will have ultimate authority over game rulings, and will have full authority over team conduct in the court area.
- k. Damaging the court area is prohibited. If a robot's design causes damage to the court elements, then it will not be allowed to compete until it can operate without causing damage. Games missed due to this situation will be forfeited.
NOTE: Damage involves **BREAKING** court components. Robots bumping into court components and causing them to shift position without breaking any court element will **NOT** be viewed as damaging the court. It is expected that all court components will be fixed firmly in place so that the court is a Neutral Factor in the competition.
- l. Games will start on time. Teams are responsible to know when their games are scheduled. Teams arriving late will be allowed to use the remainder of the time in the game. Competitors cannot enter onto the court surface or adjust their robot during a game.
- m. If a robot is mal-functioning and represents a hazard to participants, other robots or itself in the opinion of the Referee, then, the referee may stop the clock, and may authorize the shutting off the robot during a game. Disabled robots or parts of robots not generating any safety concerns will be left on the court until the game time expires.
- n. It is a Team Decision what roles team members will fill. Drivers are the competitors holding the robot controller(s) and asserting direct control over a Tele-operated robot.
- o. The Spotter would be the competitor providing navigational guidance to the driver.
- p. Competitors may change roles while a game is in progress.
- q. Competitors (Driver/s and/or Spotters) can move freely in their Assigned Courtside Team Area throughout the game.

- r. Competitors may not enter an opponent team's Assigned Courtside Team Area at any time during game play.
- s. At the start of a game, robots are expected to be in their Designated Starting Position.
- t. Robots arriving AFTER a game has started will be allowed to enter the game and use the Time remaining in the 4 min. game.
- u. Robots must not leave the contest court at any time during a game.
- v. It will be a referee's ruling that decides if an 'End of the Game Component Placement' took place before or after the game-ending buzzer sounded.
- w. If a Log or Roof piece falls out of the court, it may not be retrieved and will be considered out of the game for the remainder of the game time.
- x. Scoring will take place after the End of the Game Buzzer
- y. No aerial (flying) robots are allowed.
- z. The use of live animals to guide or power a robot is prohibited.*

* not included in national scope

1.12 COURT LAYOUT

- a. Please note: Although great pains will be made to keep the court in compliance with the drawings, some inaccuracies in construction may occur. **Please make your robot designs allowing for a possible 1/4 inch tolerance.**
 - i. The open court surface will consist of the good side of Plywood Sheets **OR** the facility floor **OR** the smooth side of Masonite Sheeting.
 - ii. Detailed court information has been included in the Appendix Section of this document.

1.13 THE ROBOT(S) RESTRICTIONS

- a. All tele-operated Robots must pass a pre-competition inspection for compliance with the safety and design rules before they will be allowed to participate in tournament games.
- b. **Note:** Robots must remain in compliance with these rules throughout the competition. If teams fall out of compliance with these rules, then they will not be permitted to compete and will forfeit all their scheduled games until they have corrected the problem.

1.14 START OF THE GAME ROBOT STATUS

- a. When a robot's main power is turned on prior to the start of a game the robot must be in an overall 'Idle State' and the following conditions must exist:
 - i. Robots must be stationary.
- b. Robots must be in their designated Starting Location.
- c. If Team Entries involve multiple Robots / Mechanisms, then all of them must fit within starting location and must be positioned to not exceed the allowed total 4 cu ft. volume per Team.
- d. All systems may be ON.
- e. Air System Circuits may be fully charged to 100 PSI and their compressors can be ON.

1.15 OVERALL TEAM ROBOT ENTRY SIZE

- Complete Team Entries must fit within the 24 by 30 inch starting at the start of each game, as defined by the vertical plane of the starting platform.
- Complete Team Entries must not exceed an overall size of 4 cubic feet (6,912 cubic inches) at the start of each game.
- Team Entries may expand to a larger size once a game has started.

1.16 POWER SOURCES/MANAGEMENT

- The total voltage in any individual circuit cannot exceed 24 Volts.
- The maximum continuous power rating allowed in any circuit branch is 240 W, which will be limited by voltage and fuse selection. A larger main fuse can be used to provide protection for motor controllers. To calculate power in any given circuit, use the following formula:

$$\text{Power (Watts)} = \text{Voltage (Volts)} \times \text{Current (Amps)}$$

Acceptable Circuit Protection: (ESC is NOT protected by fuse)

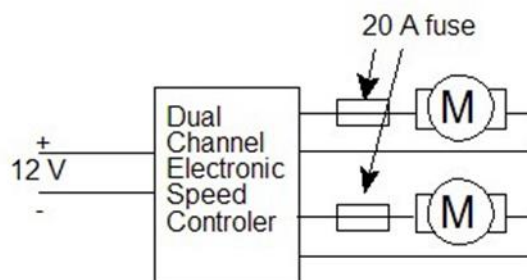

Recommended Circuit Protection: (ESC IS protected by fuse)

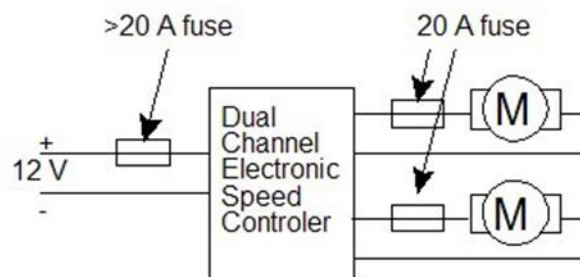

- Teams must protect themselves and the equipment in their circuits. Teams must develop circuit diagrams and calculate the appropriate values for all circuits on their robot. Teams must submit a wiring diagram of their robot's circuits.
- Each current branch path from the battery must include either an in-line fuse, resettable fuse, circuit breaker, or be connected to a dedicated fuse in a rack.
- Batteries must be complete sealed commercial battery packs.
- ALL Robots must be able to be turned off with a single motion.
- Robot Controller receivers may be in an independent circuit.
- No explosive materials of any kind may be used (ether, gunpowder, acetylene etc.)

1.17 NON-ELECTRICAL (BATTERY) ENERGY SOURCES

- a. Pressure based energy sources (air or other) may be pre-charged to a maximum of 100-PSI pressure in their reservoirs (cylinders) at the start of each game.
- b. Air pressure systems using Competitor-made or modified air pressure hardware are NOT permitted.
- c. All pressurized tanks on robots must have a pressure gauge to indicate the stored pressure and a form of automatic overpressure safety relief system.
- d. The pressure tanks and related gauges / controls must be shielded from damage due to collisions or flying target objects.
- e. The stored pressure in the tank must not exceed a maximum of 100 PSI at any time.
- f. Tension-based energy sources (elastics, springs or other) may be in either a relaxed at rest state or in a tense / compressed state at the start of each game.
- g. Laser devices are prohibited.

1.18 RECOMMENDED ROBOT CONTROLLERS

- a. It is recommended (not required) that all teams use 2.4 GHz “non-crystal” control systems on Tele-operated Robots.
- b. Teams are allowed the use of an unlimited number of channels, but only two separate tele-operated robots. Teams assume full responsibility if any interference is to occur with their respective communication systems that could render the robot(s) useless.
- c. Tele-operated Robots may not transmit audio/visual information to off the robot devices. (Ex: Having a camera transmit images real time to a computer near the driver, etc.)

1.19 PIT AREA

- a. Competitors MUST wear safety glasses when doing fabrication work involving material removal processes (grinding / cutting).
- b. Only registered competitors are permitted in the contest space.
- c. Designated teacher/industry team advisors are permitted in the pit area only to inspect the worktable setup of their team prior to the start of the tournament.
- d. Designated teacher/industry team advisors are not allowed in the pit area during tournament play.
- e. Teachers and industry advisors are not permitted to handle tools or robot parts. Students must affect all repairs and modifications on their robot.
- f. Teams will be provided with a pit area workspace on a standard project table. Depending on the number of teams and availability of space, teams may have to share a 60 by 30-inch table.
- g. It is required that teams fabricate a tabletop stand for holding their robot(s) in the pit area. This stand or these stands should hold the robot(s) securely and be capable of preventing the robot(s) from driving on or off the table in the case of either deliberate motor testing during repairs or due to random, unexpected motor activity.

1.20 OVERALL COURT DESCRIPTION

- a. The Court Playing Surface will be a 16' by 16' square.
- b. Individual Exclusive Use Team Spaces are 8' by 16' rectangles.
- c. The Perimeter Court Walls will be made using 2 by 6-inch planks.
- d. This wall will as a result will be approximately 5.5 inches tall.
- e. The court surface may vary between melamine, concrete, hardboard, or plywood.

1.21 PRE-INSPECTION FOR COMPLIANCE WITH SAFETY AND DESIGN RULES

- Mandatory Wiring Diagram provided.
- Tabletop Robot Stand
- Overall volume 4 ft³ or 6,912 in³
- No explosives/combustibles
- No lasers
- All batteries are sealed commercial batteries in good physical condition
- Batteries wired in series should be the same amp hour rating (ex. both 1500 mAh) and batteries in parallel are of same voltage (ex. both 12 volts).
- Batteries securely mounted
- Total voltage in any individual circuit does not exceed 24V
- No circuit **branch** exceeds 240W (Voltage x Fuse Current Rating, easily accessible)
- All circuits have a fuse or breaker (breakers must have **DC rating**) and all Fuses / Breakers must be readily accessible.
- Mandatory Pressure System Circuit Diagram provided.
- No Competitor-made or modified air pressure hardware being used.
- Only commercially manufactured Pressure Tanks (cylinders) can be used.
- Pressure indicator
- Pressure in tanks does not exceed 100 psi
- Over-pressure safety valve
- Pressure tanks and related gauges and controls are shielded from damage due to collisions
- Robot can be turned off with a single motion.** Radio receivers / Logic circuits may be independent of the kill switch.
- Control unit to support operator to robot communication are being used.
- Demonstration of robot functionality

Additional concerns:

Robot Evaluator Signature

Team Representative Signature

--	--

2. AUTONOMOUS CONTEST: DISASTER RESCUE

Designed by Dan Kurz

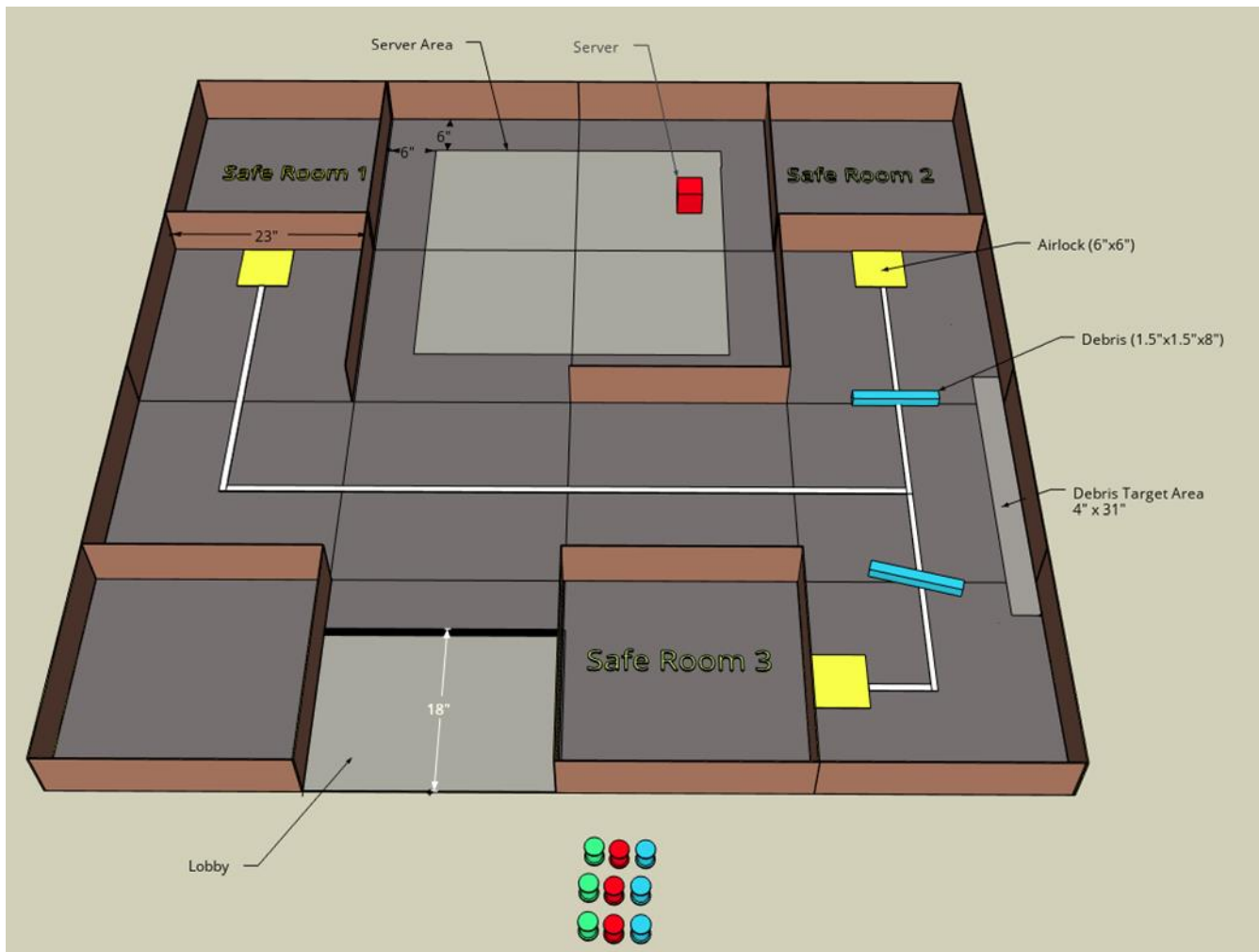

Backstory

A production factory called Tigerplex has just been hit by a powerful earthquake which has caused significant damage to the building's structure and released deadly amounts of toxic gas and radiation into the air.

Fortunately, the alarm system alerted all of the employees on site who were all able to make it into one of the 3 safe rooms. The safe rooms are equipped with communication systems and enough food and water for 3 days. Unfortunately, due to extent of the structural damage of the facility and the radiation levels, experts agree it will be at least 6 days until rescue crews are able to get the trapped employees out. In the meantime, medical supplies, food and water will need to be delivered to the airlocks outside each of the safe rooms.

The lobby of the building has been reinforced and decontaminated. The lobby serves as the only access point to the complex and is a safe zone for robots and humans. Once a robot returns from the complex to the lobby it must undergo an extensive decontamination process before humans can enter again.

The Tigerplex network was also severely damaged during the earthquake and the main server is not responding. The server contains information vital to the cleanup effort and needs to be physically removed from the complex so that technicians can access the data. Unfortunately, the only building plan that was recovered was damaged in the accident so the location of the server can only be approximated.

Your mission is to build a robot that can deliver canisters of food, water and medical supplies to the safe rooms and retrieve the server. There has been significant damage to the building and your robot may need to clear the path to accomplish its goals.

Note: The court and parts will be constructed out of the components found in the Tetrix - “Competition in a Box” set available from Studica.

<https://www.studica.com/ca/fr/SkillsCanada/skills-canada-tetrix-max-competition-in-a-box.html>



2.1 CANISTER DELIVERY

- a. Robots will be pre-loaded with up to 9 canisters (3 per safe room). They will be coloured spools representing food, water and medical supplies. Each room requires 1 of each.
- b. Robots will need to travel to each of the safe rooms and offload the required canisters in the designated airlock areas. Airlocks will be represented by 6"x6" squares of yellow duct tape.
- c. Canisters should be delivered upright and in the correct quantities.
- d. Canister Notes:
 - i. Canisters must be delivered as single units to qualify for delivery points. (They can't be lashed together)
 - ii. An arrow will indicate the top of each canister. Additional points will be given for delivering the canisters right side up.
 - iii. No points will be awarded for canisters that are not required. For example, a second canister containing water at an airlock is not required.
 - iv. A canister must be completely within the airlock at the end of the performance to qualify for points.

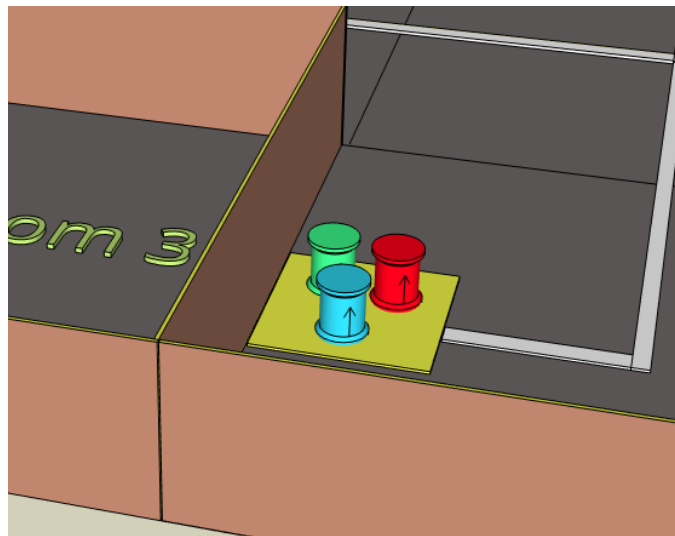

2.2 DEBRIS

- Safe rooms 2 and 3 will have “beams” (1.5”x1.5”x8” Styrofoam) that have fallen across the hall. The robot will need to move them to the side before continuing down the hall.
- There will be a target area marked on the floor that the debris will need to be moved to in order to be considered safe. Only debris completely within the target area will qualify for points.

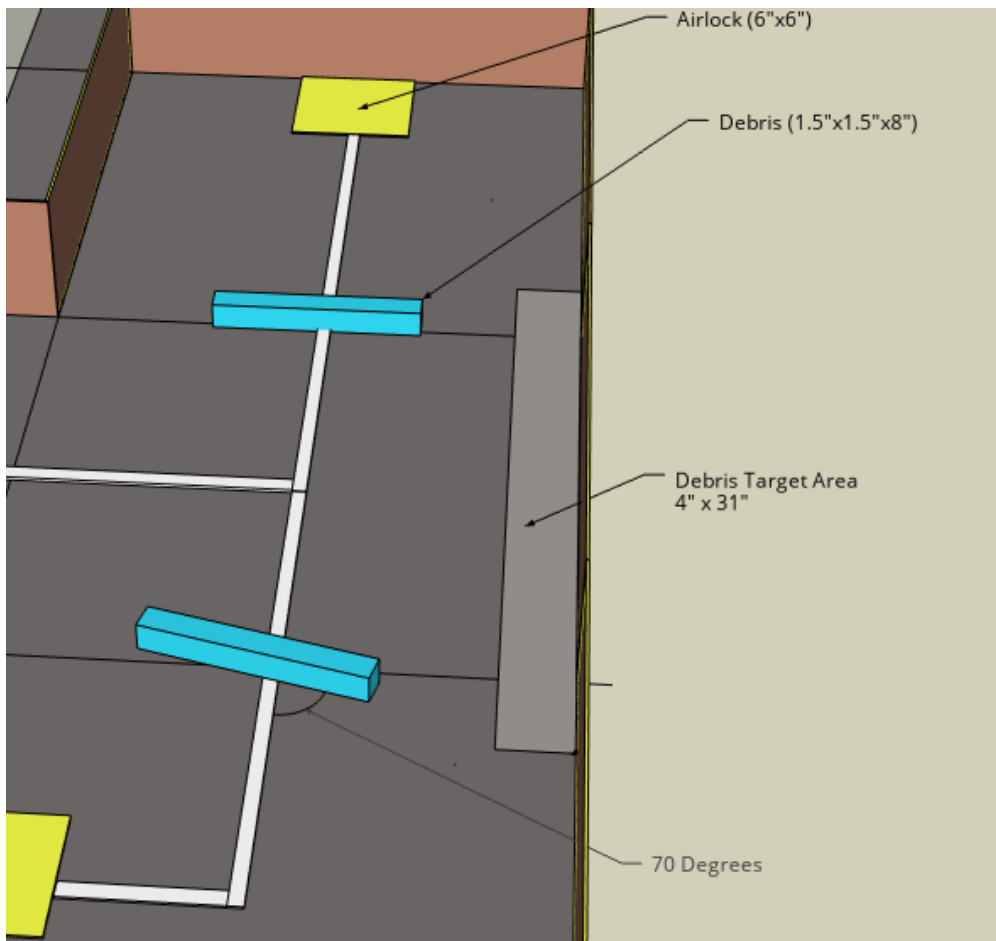
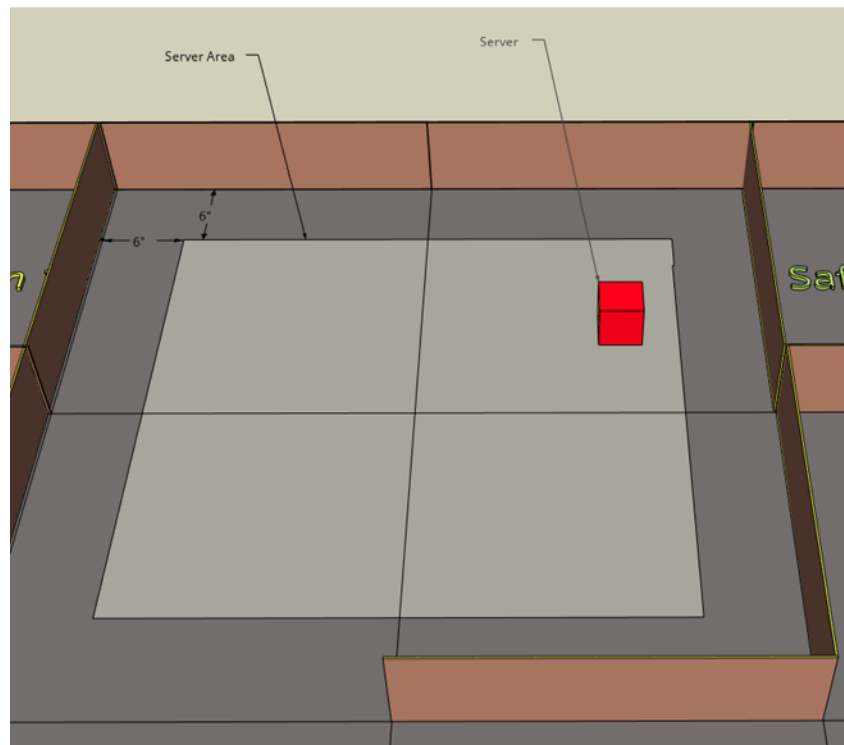

Figure 2 – Debris Layout

2.3 SERVER

- The server will be a 3"x3" Styrofoam block covered in red duct tape.
- The server will be located at an unknown position within the server area, 6" out from any walls and will be positioned square to the walls. The server area will not be marked on the floor.
- Once the robot is placed in the lobby the judge will provide the location of the server within the server area. The location will be given with respect to the left wall and the top wall in Figure 3.
- The server will qualify for points twice, once when it is fully controlled by the robot (picked up off the ground) and again when it is delivered to the lobby.



2.4 THE LOBBY

- a. The lobby is a 23"x18" rectangle at the entrance to the complex.
- b. The lobby-complex boundary will be marked with black electrical tape.
- c. Robots must start completely within the lobby.
- d. Robots must completely leave the lobby to receive any points at all.
- e. Once the performance begins, if the robot or any part of the robot enters the lobby and then exits, the performance will be considered over.
- f. At the end of the performance, the robot and the server must be completely parked within the lobby to qualify for their respective return/delivery points.

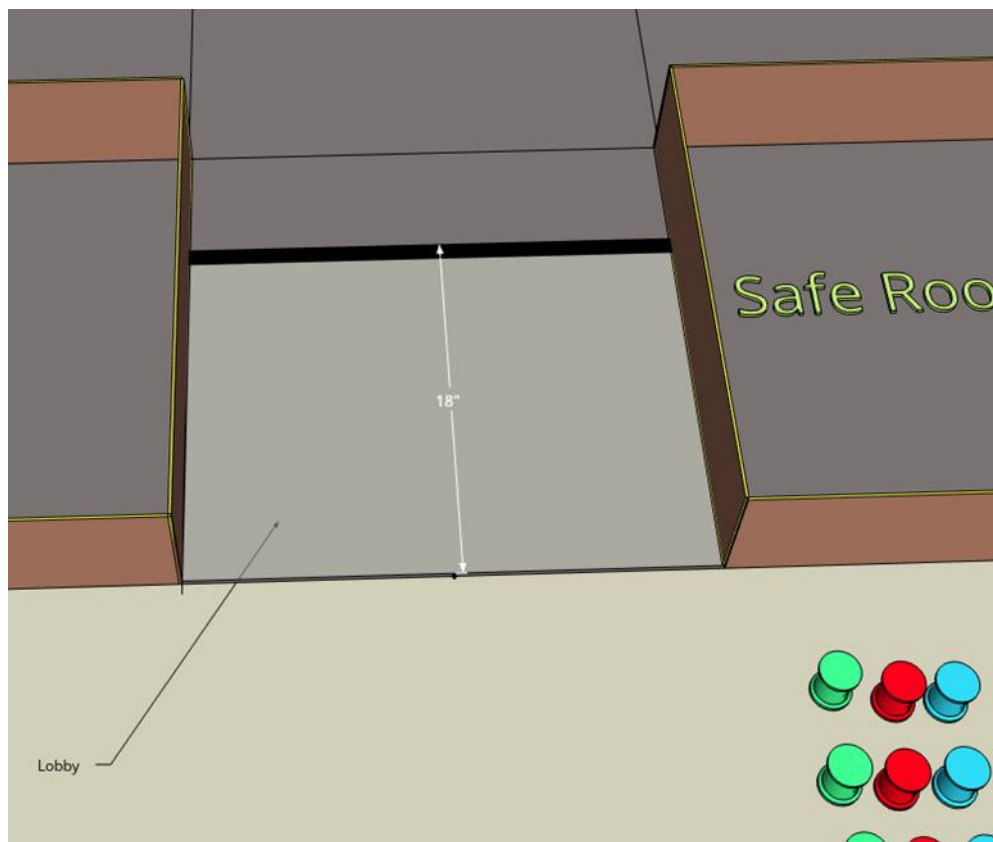

2.5 GENERAL AUTONOMOUS RULES

Robots will not be allowed to perform unless they comply with these rules.

- a. A team's entry must be a single autonomous robot.
- b. Robots must fit within a cube measuring 16" on each side at the start of each performance. They must also be able to navigate the course without moving the walls or posts.
- c. Autonomous robots must pass the Autonomous Robot Safety Inspection (Appendix A)
- d. Programs must be initiated with a single action from the operator and then robots must operate completely autonomously.

2.6 TASK SPECIFIC RULES

- a. Robots will have 8 minutes to complete the task. The timer will start when any part of the robot crosses the lobby-complex boundary.
- b. A performance will end when 8 minutes has elapsed, the bot returns to the lobby and parks or the judge has stopped the performance.
- c. Any game elements (server, debris, canisters etc...) being controlled by the robot are considered part of the robot.
- d. The judge will stop the performance if the robot is damaging the court or operating in an unsafe manner. A mark of 0 will be recorded for that performance. Damage to the court includes:
 - i. Dislodging posts from the tiles.
 - ii. Knocking over walls.
 - iii. Crushing or breaking game elements such as debris, canisters or the server.
 - iv. Any other action that the judge considers damage to the court.

2.7 COURT SET UP AND CONSTRUCTION

- a. The court will be constructed out of the components found in the Tetrix “Competition in a Box” set.
- b. The court will be made up of 16 floor tiles in a 4x4 grid.
- c. Posts will be fastened to the matts with double sided tape.
- d. The posts and walls create a grid where each square is 23”x23” on the inside of the walls.
- e. White tape will be $\frac{3}{4}$ ” electrical tape and will be placed along the centerline between the walls and according to the diagram on the cover of this document.
- f. Yellow duct tape will be used to mark the airlocks. Airlocks will be centered on the walls they are adjacent to.
- g. The debris will be centered on the tape and be either square to the tape or rotated 15°. See Fig 2.
- h. Both the server and the debris will be made out of the same foam as the roof in the Log Cabin competition.
- i. 2 strips of grey duct tape will be used to mark the debris target area. It is 31” long and centered on the wall section it is adjacent to. See Fig 2.
- j. Black electrical tape will be used to mark the lobby-complex boundary. See Fig 4.

Pro Tip: *Lightly sand the tiles so the tape sticks better. A foam sanding block works well.*

2.8 AUTONOMOUS SCORE CHART

Team:	Date:	Attempt:
--------------	--------------	-----------------

Operation	Value	Number Complete	Total
Deliver a required canister to an airlock	3		
Deliver the required canister upright.	2		
Move debris from the path to the target area	10		
Control the Server	5		
Deliver the server to the lobby	5		
Return to Lobby	10		
Total:	75		

Competitor Signature	
Judge Signature	

APPENDIX A – AUTONOMOUS ROBOT INSPECTION CHECKLIST

- Mandatory Wiring Diagram provided.
- Tabletop Robot Stand
- Overall volume fits within a 16"x16"x16" cube
- No explosives/combustibles
- No lasers
- All batteries are sealed commercial batteries in good physical condition
- Batteries wired in series should be the same amp hour rating (ex. both 1500 mAh) and batteries in parallel are of same voltage (ex. both 12 volts).
- Batteries securely mounted
- Total voltage in any individual circuit does not exceed 24V
- No circuit **branch** exceeds 240W (Voltage x Fuse Current Rating, easily accessible)
- All circuits have a fuse or breaker (breakers must have **DC rating**) and all Fuses / Breakers must be readily accessible.
- Mandatory Pressure System Circuit Diagram provided.
- No Competitor-made or modified air pressure hardware being used.
- Only commercially manufactured Pressure Tanks (cylinders) can be used.
- Pressure indicator
- Pressure in tanks does not exceed 100 psi
- Over-pressure safety valve
- Pressure tanks and related gauges and controls are shielded from damage due to collisions
- Robot can be turned off with a single motion.**
- Demonstration of robot functionality on stand.

Additional concerns: _____

Robot Evaluator Signature

Team Representative Signature

--	--

APPENDIX B – PHOTOS OF THE COURT

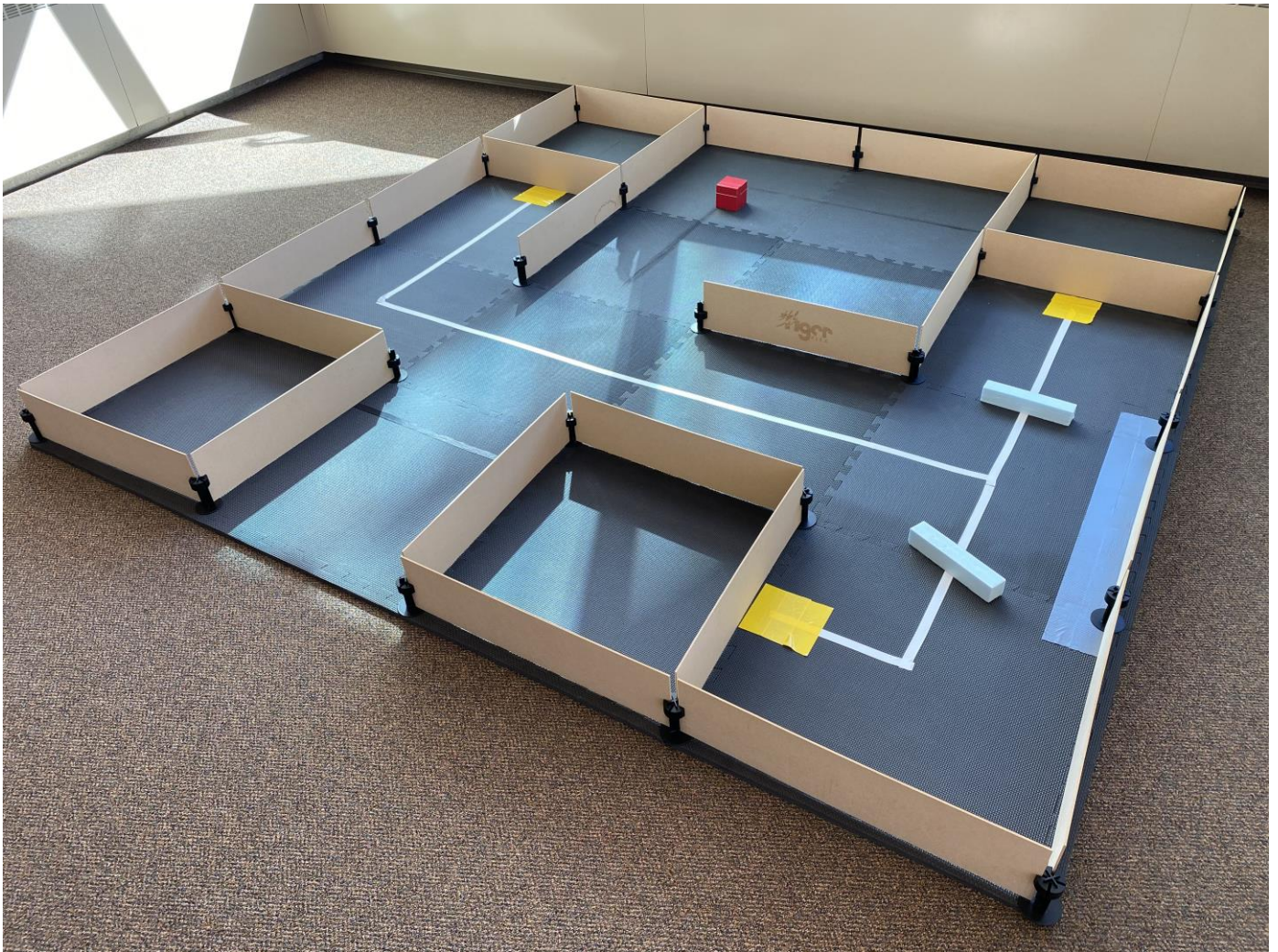

Photo 1.1 – Wall Layout

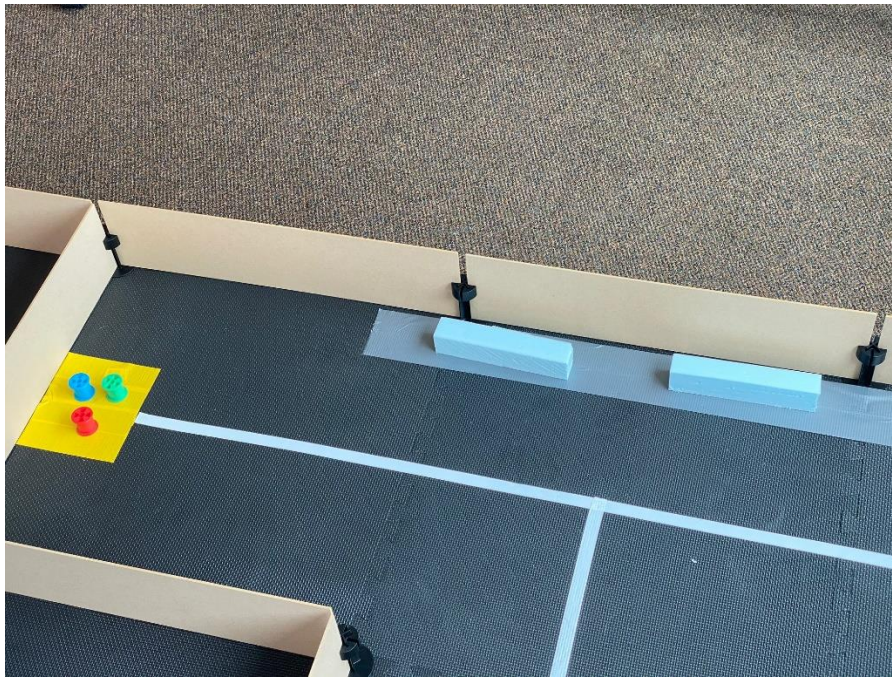

Photo 1.2 – Debris in target area and Spools Delivered



Photo 1.3 – Spools Marked

APPENDIX C – DRAWINGS OF THE COURT

**2021 SKILLS CANADA NATIONAL
ROBOTICS COMPETITION**

QUEBEC CITY, QUEBEC, CANADA

APPENDIX A: COURT AREA DIMENSIONS
AND DETAILS - ISO A1 SIZE

DRAWING INDEX		
SHEET NO.	DWG. TITLE	DWG. NO.
0	COVER SHEET	SC-ROB-0
1	COURT AREA DIMENSIONS	SC-ROB-1
2	MATERIAL CUT SHEET LABELS	SC-ROB-2
3	MATERIAL CUT SHEET	SC-ROB-3
4	SMALL PART DETAILS	SC-ROB-4

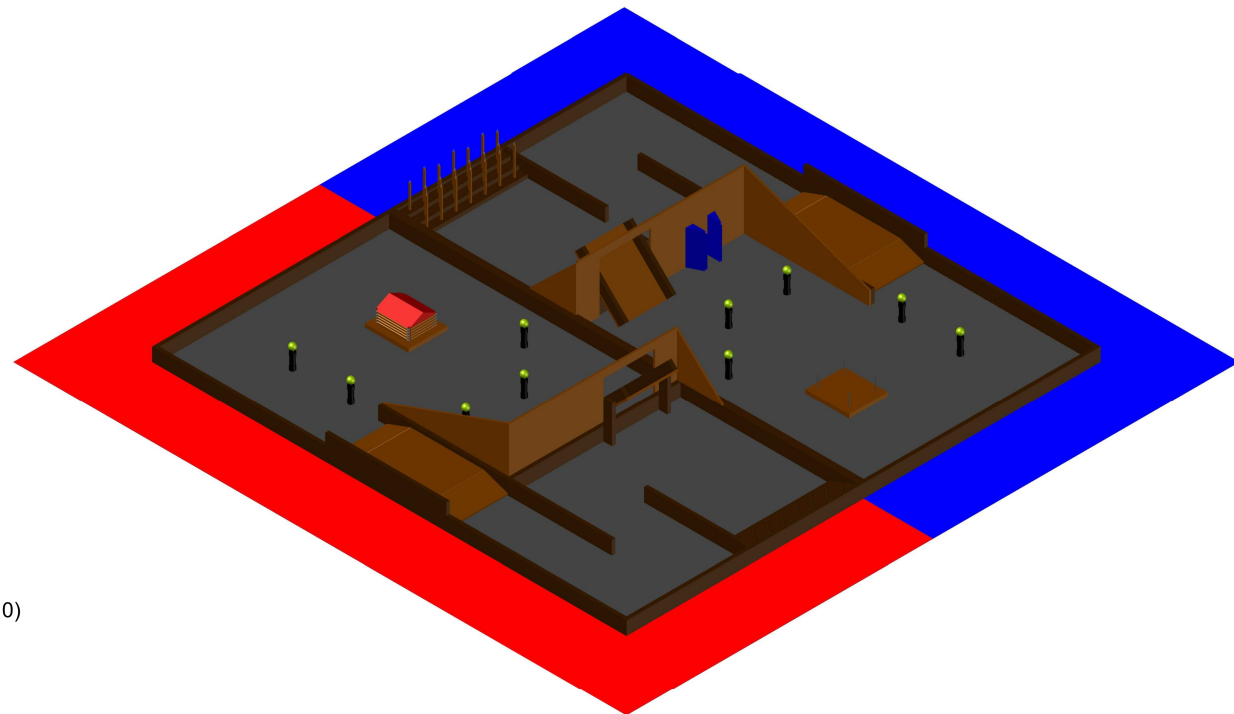

ISSUED FOR SCOPE DOCUMENT: JULY 27TH, 2020 (REV. 0)

① OVERALL COURT AREA
SCALE = N/A

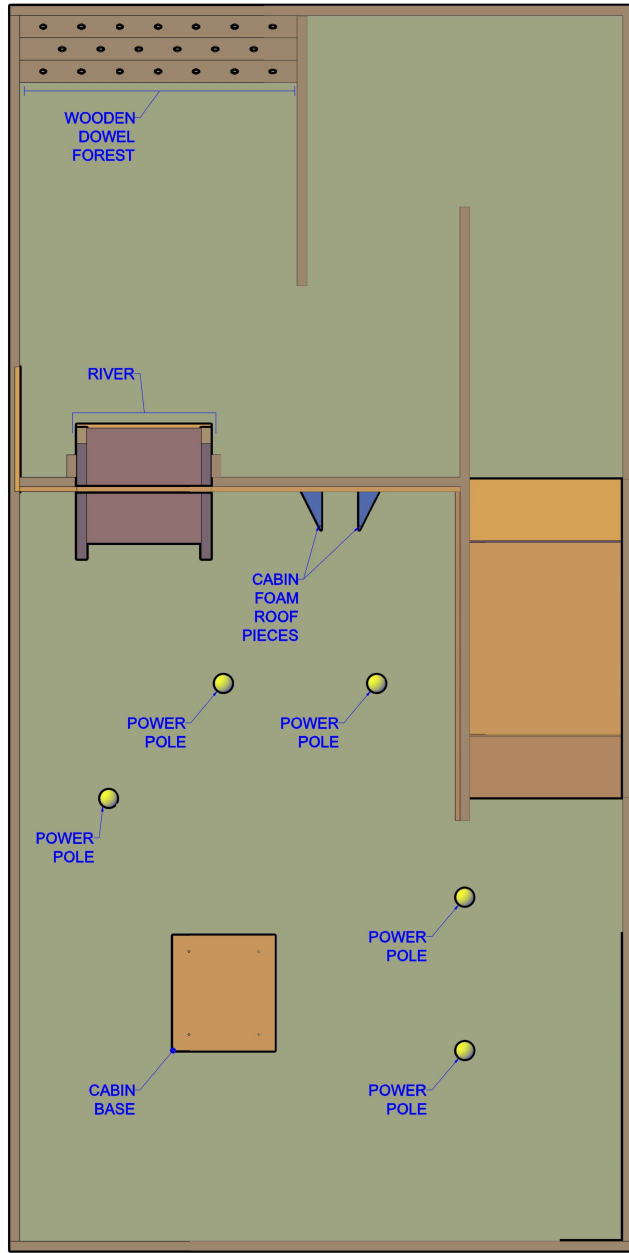

1 COURT LAYOUT
SCALE = 1:10 (ON ISO A1 SHEET)

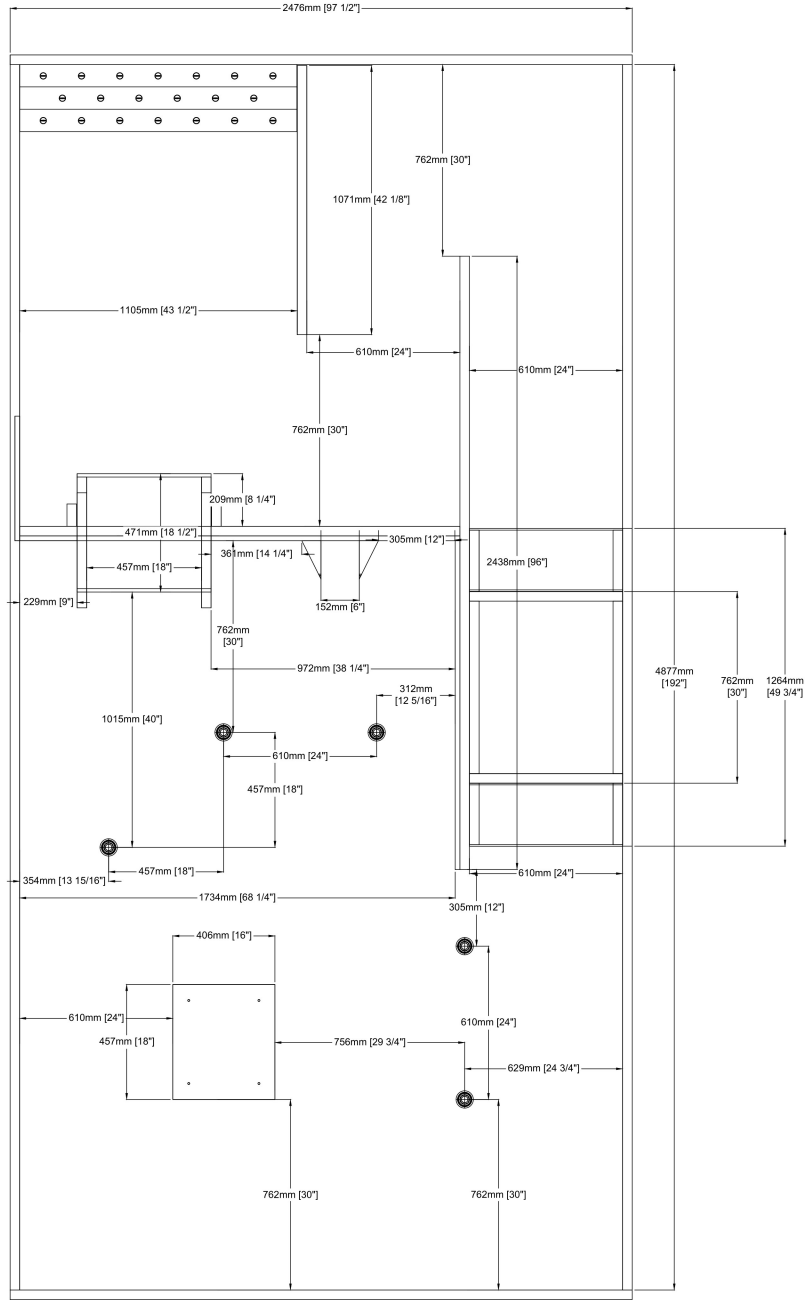

2 COURT DIMENSIONS
SCALE = 1:10 (ON ISO A1 SHEET)

Notes:

- ALL MATERIALS LISTED ON ALL DRAWINGS (SC-ROB-1, SC-ROB-2, SC-ROB-3 AND SC-ROB-4) REPRESENT INFORMATION AND DIMENSIONS FOR A SINGLE COURT AREA, REPRESENTING A SINGLE TEAM'S SIDE OF THE COMPETITION FLOOR SPACE. TO BUILD A FULL COURT REPRESENTING 2 TEAM COURT AREAS, MULTIPLY MATERIAL QUANTITIES BY 2.
- SEE DRAWING SC-ROB-04 FOR DIMENSION DETAILS ON SMALLER COURT PIECES, INCLUDING THE FOAM PIECES, UTILITY POLES, AND HOUSE BASE BOLTS.

-	-	-	-
0	ISSUED FOR SCOPE DOCUMENT	SM	JUL 27/20

REV 0	DESCRIPTION:	BY:	DATE:
STATUS: NATIONAL SCOPE ISSUE			

CLIENT: SKILLS CANADA

TITLE: 2020 NATIONAL ROBOTICS COMPETITION COURT AREA DIMENSIONS

SCALE AT A1:	DATE:	DRAWN:	DESIGNED:
AS NOTED	JUL 27/20	SM	NTC
PROJECT NO:	DRAWING NO:	REVISION:	
-	SC-ROB-1	0	

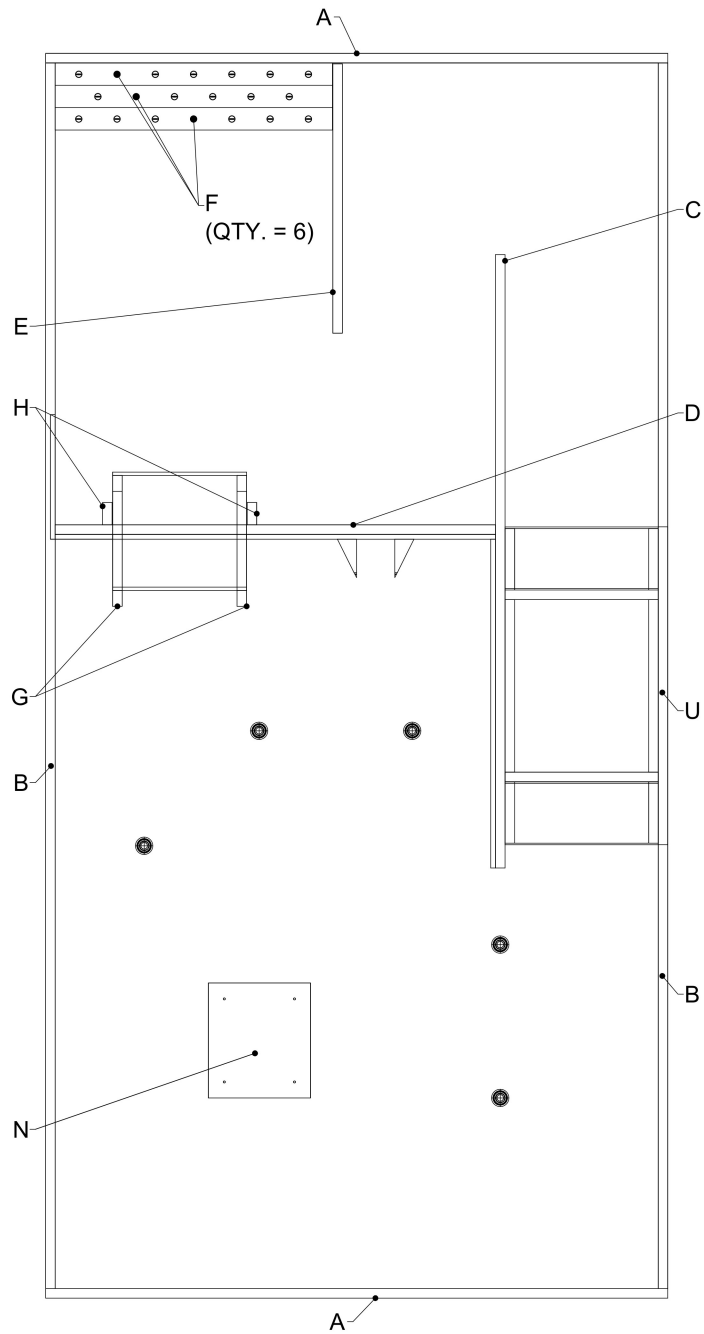

1 COURT MATERIAL LABELLING
SCALE = 1:10 (ON ISO A1 SHEET)

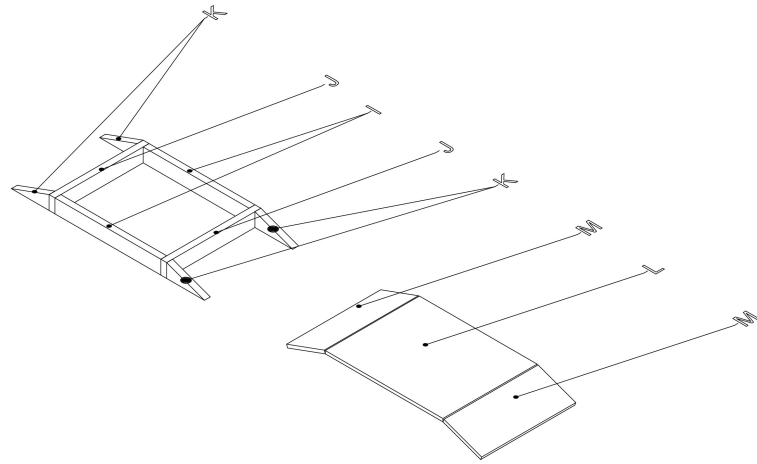
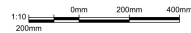

2 RAMP MATERIAL LABELLING
SCALE = N/A

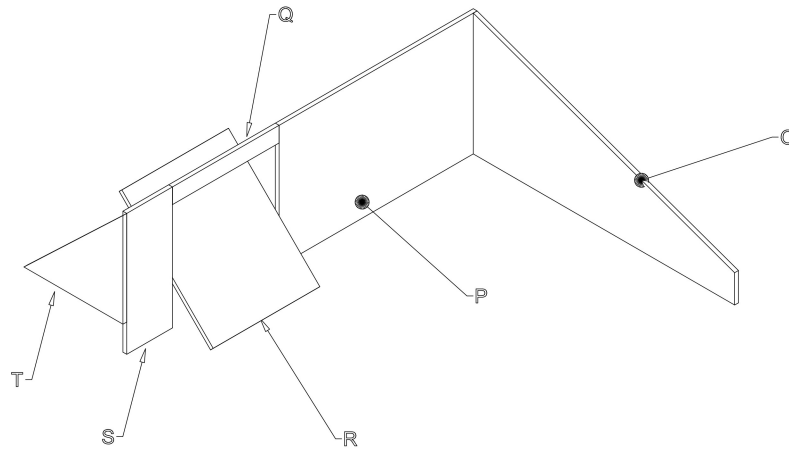

3 UPRIGHT PLYWOOD MATERIAL LABELLING
SCALE = N/A

Notes:

1. ALL MATERIALS LISTED ON ALL DRAWINGS (SC-ROB-1, SC-ROB-2, SC-ROB-3 AND SC-ROB-4) REPRESENT INFORMATION AND DIMENSIONS FOR A SINGLE COURT AREA, REPRESENTING A SINGLE TEAM'S SIDE OF THE COMPETITION FLOOR SPACE. TO BUILD A FULL COURT REPRESENTING 2 TEAM COURT AREAS, MULTIPLY MATERIAL QUANTITIES BY 2.

-	-	-	-
-	-	-	-
0	ISSUED FOR SCOPE DOCUMENT	SM	JUL 27/20

REV: 0	DESCRIPTION:	BY:	DATE:
STATUS:		NATIONAL SCOPE ISSUE	

CLIENT:
SKILLS CANADA

TITLE:
2020 NATIONAL ROBOTICS COMPETITION
MATERIAL CUT SHEET LABELS

SCALE AT A1:	DATE:	DRAWN:	DESIGNED:
AS NOTED	JUL 27/20	SM	NTC
PROJECT NO:	DRAWING NO:	REVISION:	
-	SC-ROB-2	0	

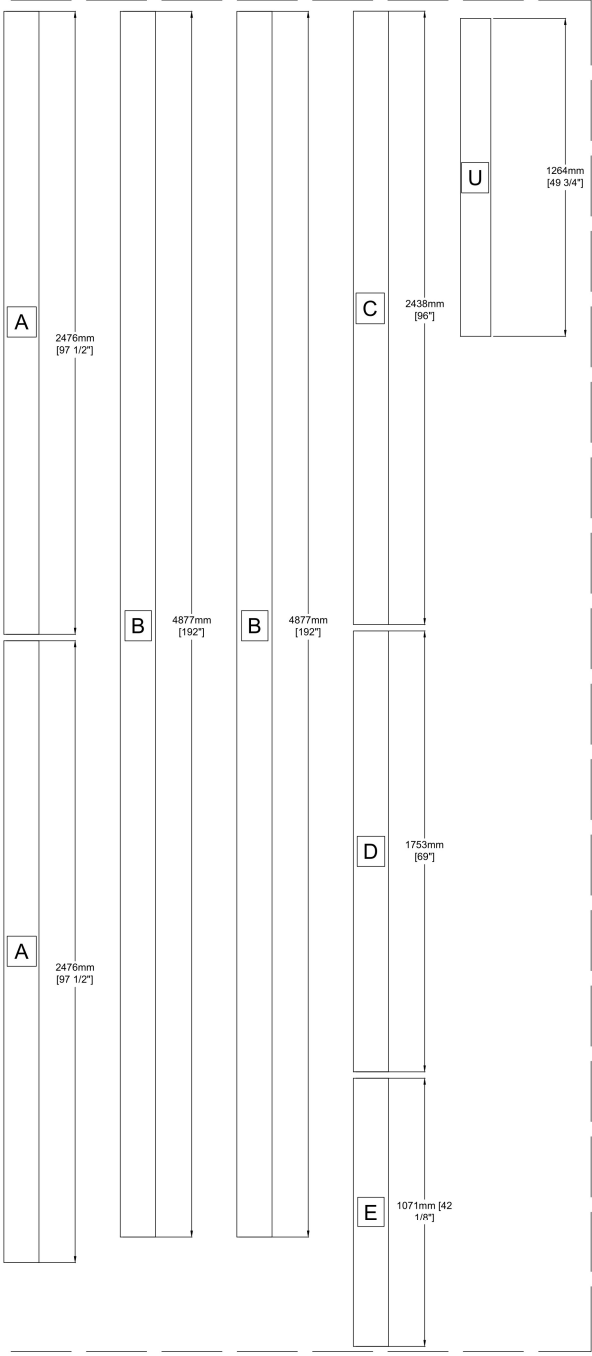

1 STANDARD 2x6" DIMENSIONS
SCALE = 1:10 (ON ISO A1 SHEET)

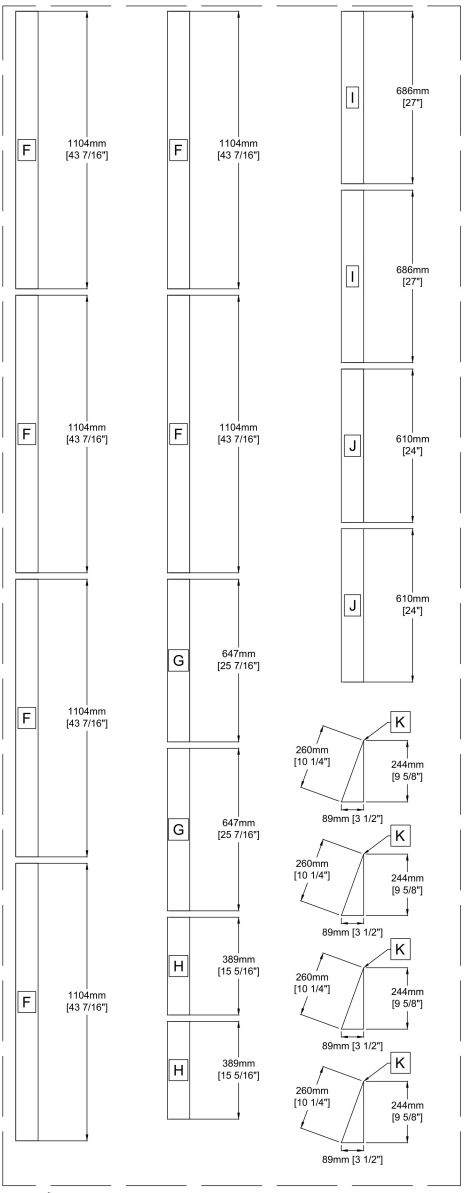

2 STANDARD 2x4" DIMENSIONS
SCALE = 1:10 (ON ISO A1 SHEET)

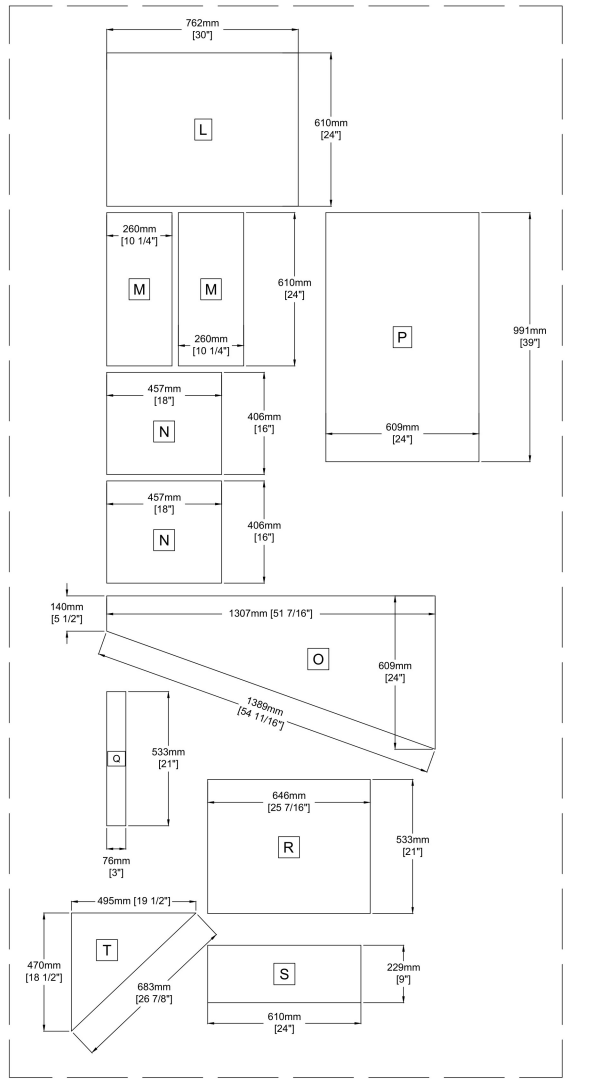

3 STANDARD 3/4" PLYWOOD DIMENSIONS
SCALE = 1:10 (ON ISO A1 SHEET)

Notes:

1. ALL MATERIALS LISTED ON ALL DRAWINGS (SC-ROB-1, SC-ROB-2, SC-ROB-3 AND SC-ROB-4) REPRESENT INFORMATION AND DIMENSIONS FOR A SINGLE COURT AREA, REPRESENTING A SINGLE TEAM'S SIDE OF THE COMPETITION FLOOR SPACE. TO BUILD A FULL COURT REPRESENTING 2 TEAM COURT AREAS, MULTIPLY MATERIAL QUANTITIES BY 2.

REV 0	DESCRIPTION	BY:	DATE:
0	ISSUED FOR SCOPE DOCUMENT	SM	JUL 27/20

STATUS: **NATIONAL SCOPE ISSUE**

CLIENT: **SKILLS CANADA**

TITLE: **2020 NATIONAL ROBOTICS COMPETITION MATERIAL CUT SHEET**

SCALE AT A1:	DATE:	DRAWN:	DESIGNED:
AS NOTED	JUL 27/20	SM	NTC
PROJECT NO:	DRAWING NO:	REVISION:	
-	SC-ROB-3	0	

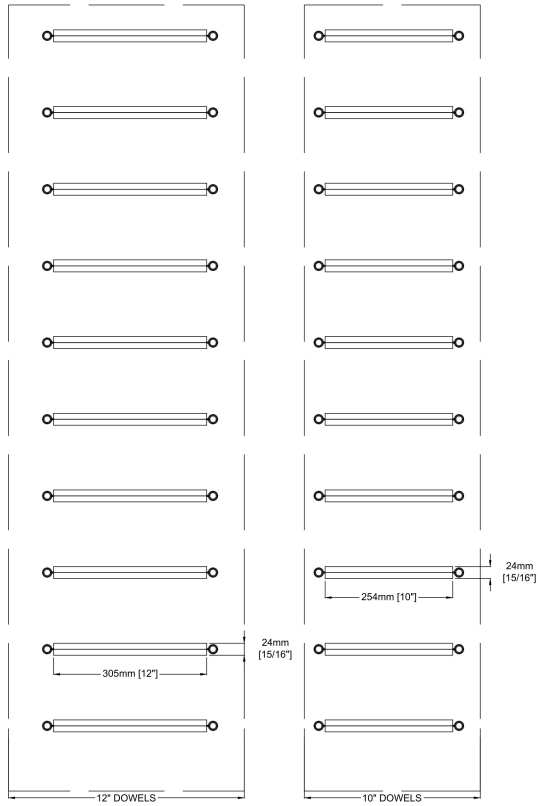

① **FOREST DOWEL DETAILS**
SCALE = 1:5 (ON ISO A1 SHEET)

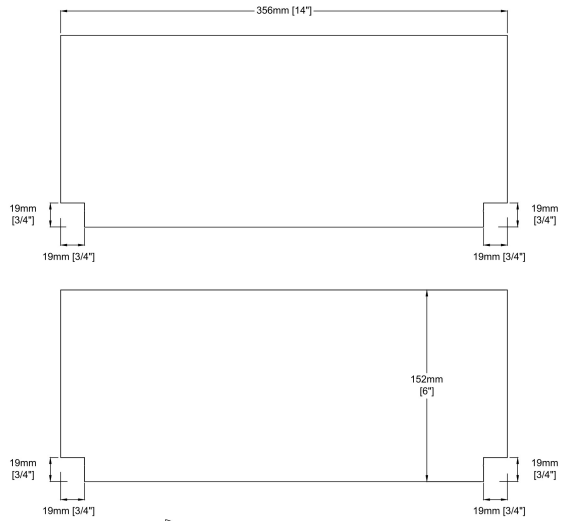

② **FOAM DETAILS**
SCALE = 1:2 (ON ISO A1 SHEET)

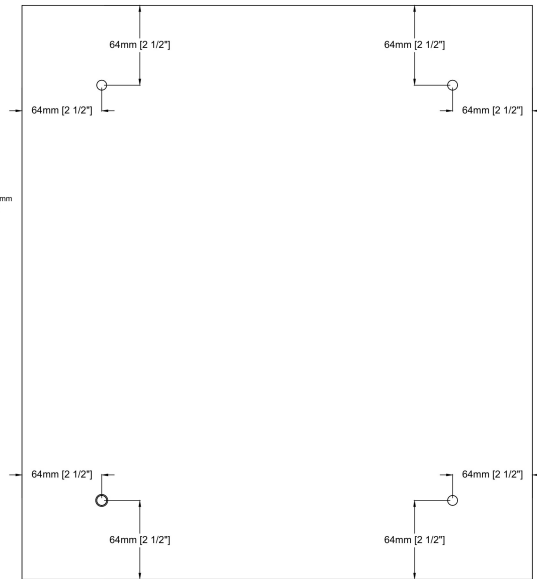
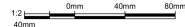

⑤ **HOUSE BASE DETAILS**
SCALE = 1:2 (ON ISO A1 SHEET)

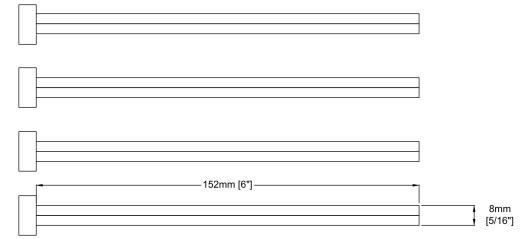

③ **WOODEN BASE BOLTS**
SCALE = 1:1 (ON ISO A1 SHEET)

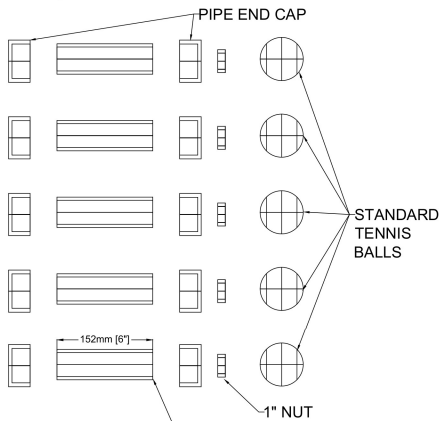
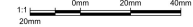

④ **UTILITY POLE DETAILS**
SCALE = 1:4 (ON ISO A1 SHEET)



2021 Skills National Robotics Competition: Bill of Materials (1 Court)			
Description	Model Description	Quantity	Web Url
Dowel Eye Hooks	Everbilt 1-5/8 Inch Zinc Large Screw Eye (8 Pack)	6	https://bit.ly/2Ej5f5L
Wooden Dowels	Alexandria Moulding Hardwood Dowel	6	https://bit.ly/3ZVlg2v
Foam Insulation	Foamular C-200 Extruded Polystyrene Rigid Insulation	1	https://bit.ly/3hKW6G6
Tennis Balls	Wilson Prime All Court Tennis Ball 4 Pack (12 Balls)	1	https://amzn.to/3iDSi0q
Power Pole Hex Nut	Steel Hex Nut, Zinc Plated Finish, Grade 5, 1"-8 Threads	1	https://amzn.to/2CX2bBq
2"x6" x 10' Wood	2" x 6" x 10' Standard SPF Dimension Lumber	4	https://bit.ly/306D9cx
2"x6" x 8' Wood	2" x 6" x 8' Standard SPF Dimension Lumber	5	https://bit.ly/2BzgvvA
2"x4" x 8' Wood	2" x 4" x 8' Standard SPF Dimension Lumber	6	https://bit.ly/2OZztzZ
3/4" x 4' x 8' Plywood	3/4" x 4' x 8' Standard Sheet of Plywood	2	https://bit.ly/3hE7LrF
ABS Pipe	1-1/2" x 12' Standard ABS Pipe	1	https://bit.ly/302NzQ8
ABS Cap	1-1/2" ABS Slip On Test Cap	10	https://bit.ly/2B8vWwD

⑥ **BILL OF MATERIALS**
SCALE = N/A

Notes:

- ALL MATERIALS LISTED ON ALL DRAWINGS (SC-ROB-1, SC-ROB-2, SC-ROB-3 AND SC-ROB-4) REPRESENT INFORMATION AND DIMENSIONS FOR A SINGLE COURT AREA, REPRESENTING A SINGLE TEAM'S SIDE OF THE COMPETITION FLOOR SPACE. TO BUILD A FULL COURT REPRESENTING 2 TEAM COURT AREAS, MULTIPLY MATERIAL QUANTITIES BY 2.

REV	DESCRIPTION	BY	DATE
-	-	-	-
0	ISSUED FOR SCOPE DOCUMENT	SM	JUL 27/20

STATUS: **NATIONAL SCOPE ISSUE**

CLIENT: **SKILLS CANADA**

TITLE: **2020 NATIONAL ROBOTICS COMPETITION MATERIAL CUT SHEET**

SCALE AT:	DATE	DRAWN:	DESIGNED:
AS NOTED	JUL 27/20	SM	NTC
PROJECT NO:	DRAWING NO:	REVISION:	
-	SC-ROB-4	0	